



nuova
SIMONELLI®
espresso coffee machines

G60



LIBRETTO ISTRUZIONI
USER HANDBOOK

Istruzioni Originali
Translation of the Original Instructions

Versione Italiana Pag. 2

English versionPag. 8

EN PRECAUTIONS AND SAFETY FEATURES EN

Machine design has taken into account all reasonable user safety precautions; nevertheless, particular conditions of installation and/or handling may create unforeseen situations beyond the installer's control which will require case-by-case evaluation of residual risks.

We recommend keeping the following in mind:

- Always handle the machine with care to avoid the danger of its falling.
- The packing materials (carton, cellophane, staples, polystyrene, etc..) can cut, wound or create hazards if used improperly or handled carelessly. Store such materials out of reach of children and irresponsible persons.
- This symbol on the appliance or package means that the appliance must not be considered as normal household refuse but that it must instead be delivered to an appropriate collection centre for the recycling of electric and electronic appliances. Make sure that this appliance is disposed of correctly and you too will be making your contribution to the prevention of negative effects on health and the environment, which could otherwise be caused by inadequate disposal. Recycling materials helps to preserve our natural resources. For more information about how to recycle this product, you can contact your local council office, local refuse disposal service or the retailer from whom you purchased the appliance.
- Before carrying out any installation or adjustment process, be sure to have read and thoroughly understood the warnings in this manual.
- The company cannot be held liable for any damage to people or property resulting from failure to respect the instructions concerning safety, installation and maintenance contained in this manual.
- The power cord of this appliance must never be replaced by the user. In case of damage, switch the appliance off and contact only the manufacturer or related after-sales service, otherwise a skilled personnel for replacement.
- Should you decide to no longer use this type of appliance, we recommend that you make it inoperative: unplug the appliance from the mains socket and cut off the power cord.
- All defects and/or anomalous machine behaviour should be reported immediately to authorized installation and/or maintenance personnel.
- Before connecting the machine, check that electrical power supply corresponds to the specifications on the data plate.
- In case of incompatibility between the plug and the socket, have the plug replaced with a suitable type by the manufacturer, his after-sales service, or by skilled personnel, who should also check that the section of the plug wires is suitable for the power absorbed by the appliance.
- Avoid use of multiple-plug adapters and extension cords.
- The ground wire must be connected; the electrical system must meet the standards set by local safety laws and regulations.
- The machine must be installed only by authorized, qualified personnel.
- Check that the machine components have suffered no damage during shipping; in the case defects or anomalies are found, interrupt installation and request replacement.



APPLICATIONS AND USE

- This grinder dispenser has been devised for professional use by trained personnel.
- The grinder/dispenser must be used only for the application for which it was designed; that is, grinding roasted coffee beans. Any other use must be considered improper and therefore dangerous.
- The manufacturer shall not be held responsible for damages deriving from improper, erroneous or unreasonable use of the machine.
- The appliance must not be used by children or people with reduced, physical, sensorial or mental abilities. It must also never be used by people without the necessary skills and experience unless under supervision or during training.
Do not allow children to play with this equipment at any time.
- The machine is not designed for use in extreme environmental conditions and in any case at temperatures outside the -5°C to $+30^{\circ}\text{C}$ range.
- The user must respect the general safety regulations in force in the country in which the machine is installed as well as the rules of common sense, and shall be responsible for ensuring that periodic machine maintenance is correctly performed.
- The persons installing and using the machine and performing machine maintenance shall inform the manufacturer of any defects or damages due to wear that might jeopardize the original safety features of the machine.
- The installer shall be responsible for checking that the machine is installed in tolerable environmental conditions such as to not to create health or safety hazards for those using the machine.
- Any responsibility deriving from components manufactured and installed on the machine shall be assumed by the respective manufacturers; responsibility attributable to the persons authorized to use the machine shall be assumed by the customer.
- The device can be used 24 hours a 24 with intermittent service as listed on the nameplate values Ton and Toff. The machine components are designed and built to ensure at least 1000 hours' operation.
- Good cleaning and maintenance also contribute to determining long machine life.

BASIC SAFETY PRECAUTIONS

- Never touch the machine with damp or wet hands.
- Never use the machine when barefoot.
- Never attempt to unplug the machine by pulling the power cord or the machine itself.
- Do not expose the machine to atmospheric agents (sun rain, etc..).
- Never allow the machine to be used by children or by irresponsible persons.
- Always use the appliance on a flat, steady surface that is able to support its weight.

- Always unplug the machine from the power supply before performing any cleaning or maintenance operations.
- Do not use water jets or detergents for cleaning the appliance.
- In the case of machine breakdown or malfunction switch the machine off and do not tamper with it.
- For repairs contact only an authorized service center and request use of original spare parts.
- Non-observance of the above precautions may make the machine unsafe for future use.
- Do not leave the machine switched on when not in use. Unplug the machine when not in use.
- Do not obstruct the ventilation and/or heat dissipation openings and/or slits nor introduce water or any other liquids into same.
- Should the wire be damaged, have it immediately repaired by the manufacturer, his authorized after-sales service, or skilled personnel.
- Never insert spoons, forks or other utensils into the pouring lip (10) (see Fig. 1), or into the coffee grain container (7) (see Fig. 1) for any reason whatsoever while the appliance is operating.
- Always switch off the appliance before removing blockages from the pouring lip.
- Never place the appliance in water or other liquids.
- Should a foreign body stop the motor, switch the machine off immediately and contact an authorized service center.

WARNING

Those machines bearing the "EL. MOTOR WITH THERMAL PROTECTION" indication are equipped with device which protects the motor from overheating.

When this device is engaged, do not attempt to operate the machine: isolate the machine from the power supply and eliminate the cause of the trouble before re-starting.

1. GENERAL INFORMATION

MANUFACTURER:

NUOVA SIMONELLI - Via M. d'Antegiano, 6 - Belforte del Chienti, Macerata (MC) - Italy

COFFEE GRINDER MODEL:

G60

2. TECHNICAL DATA

DESCRIPTION	MODEL
	G60
Voltage (V)	110/120
Frequency (Hz)	50/60
Power consumption (W)	480
Motor power (W)*	245
RPM	1300/1600
Productivity (Kg/h)	10
Weight when empty (Kg)	9
Height (mm)	410
Width (mm)	190
Depth (mm)	290

(*) The value given is for the actual revolutions of the burrs.

3. IMPORTANT INFORMATION

This manual is designed for use by the user of the machine and/or by those performing maintenance on the machine and must be considered an integral part of the machine itself. This manual provides information concerning correct use and appropriate maintenance of the machine, as well as useful indications for ensuring user safety. This manual must be preserved for the entire working life of the machine and must be transferred, together with the machine, to future users or owners. The information contained in this manual must not be construed as substituting the safety prescriptions and the technical data regarding installation and operation carried on the machine itself and on the packing materials. This manual reflects the current state of machine technology and shall not be considered obsolete solely because updated at a later date on the basis of acquired experience. The manufacturer reserves the right to make modifications to this manual with no obligation to update previous versions except in exceptional cases. Improper use of the machine or use in manners other than those described in this manual shall invalidate the guarantee conditions and shall release the manufacturer from all responsibility, the machine must be used only by adult, responsible persons. This manual must be preserved with care: the manufacturer declines all responsibility for damages to persons or things or to the machine itself deriving from improper use or use in manners other than those described herein or in the case the maintenance and safety precautions described herein are not respected.

3.1 PRESERVATION OF THE MANUAL

This manual must at all times be available to the machine user and/or the persons performing maintenance on the machine, who must be provided with full information regarding correct machine use and residual risks.

This manual must be preserved in a clean, dry place away from sources of heat. This manual must be used in a manner such as not to damage any part of its contents.

Do not remove, tear out or re-write any part of this manual for any reason. In case of loss of this manual or for further information, please contact your area retailer or the manufacturer.

4. APPLIANCE DESCRIPTION (see Fig. 1)

- | | |
|---|---|
| <ul style="list-style-type: none"> 1 LCD Display 2 Decreasing key 3 Luminous key for 1 coffee dose 4 Increasing key 5 Luminous key for 2 coffee dose 6 Container cover 7 Coffee bean container | <ul style="list-style-type: none"> 8 Coffee bean container for opening/closing tab 9 Grinding adjusting knob 10 Dispensing funnel 11 Filter holder fork 12 Power ON switch |
|---|---|

5. STARTING UP

5.1 LOCKING THE CONTAINER

Before operating the appliance, it is necessary to fit the coffee bean container (7).

- Insert the container (7) into its seat (see Fig. 2), positioning it so that the hole lines up with the screw on the back part of the appliance.
- Tighten the lock screw (see Fig. 3).



6. INSTRUCTIONS FOR USE

6.1 INTRODUCTION

This appliance can make very precise doses as it refers to grinding time.

It is furthermore necessary to set up the appliance before operating, by determining first of all the coffee blend type (more roasted or less) and the degree of grinding. Grinding time is then set for each dose key by weighting the grinding product.

- After having plugged the appliance in, push the tab (8) at the bottom of the coffee bean container (7) to close it (see Fig. 4).
- Remove the cover (6) from the container (7) and fill it with coffee beans.
- Press the power ON button (12) that must light.
- Pull the tab (8) permitting passage of coffee beans.
- Place the filter holder onto the fork (11) to dispense the ground coffee from the corresponding funnel (10). Select the single or double dose through the corresponding keys

(3)  or (5)  . Dispensing stops once the preset time has elapsed.

6.2 GRINDING SETTING

Set grinding by means of the adjusting knob (9), by rotating it clockwise to make powder finer or anticlockwise to increase the size of its grain as shown on the knob (see Fig. 5). Setting is stepless; it is to be gradually performed, by grinding some coffee every two notches maximum.

When knob is rotated of a turn with stationary motor, the appliance may stop.

6.3 SPOUT ORIENTATION ADJUSTMENT DISPENSING

- According to filter holder used, adjust height of the fork (12) in order to permit a correct coffee dispensing.

6.4 APPLIANCE SETTING

Display indicator legend (see Fig. 6)

- | | | | |
|----|---|----|---|
| 13 | Dispensing time of preset 1 coffee dose | 17 | Counter of dispensed 1 coffee dose |
| 14 | Continuous dispensing enabled | 18 | Padlock (locked programming) |
| 15 | Dispensing time of preset 2 coffee dose | 19 | Dispensing visualization of 2 coffee dose |
| 16 | Dispensing visualization of 1 coffee dose | 20 | Counter of dispensed 2 coffee doses |

7. CLEANING AND MAINTENANCE

ATTENTION

Unplug the appliance before performing any cleaning and maintenance operation.

ATTENTION

Do not pull the power cable or the appliance itself to disconnect the plug from the power supply socket.

7.1 CLEANING

Cleanliness is a basic aspect for the proper functioning of the coffee grinder with a dosing unit. A neglected coffee grinder with dosing unit may have a negative impact on coffee dispensing as well as on the accuracy of dose and grinding. Before cleaning, make sure the appliance is unplugged. At least once a week, clean the coffee bean container (7), removing the oily coat left by coffee beans by means of a clean cloth.

It is furthermore necessary to often clean (several times a day) the dispensing spout through a brush and a vacuum cleaner.

In case such operations are not carried out, the aromatic oily part contained in coffee may turn rancid with negative consequences on coffee, furthermore the lack of cleanliness may jeopardize regularity of the dose itself.

Clean the base by means of a damp cloth.

7.2 MAINTENANCE

ATTENTION

Maintenance is to be performed only by skilled personnel authorized by the manufacturer.

ATTENTION

Do not carry out improvised or precarious repairing and do not use non original spare parts.

In order to ensure a proper functioning of the appliance, check and eventually replace the blades every 350 Kg of ground coffee for flat blades.

8. TROUBLESHOOTING

Contact skilled personnel.

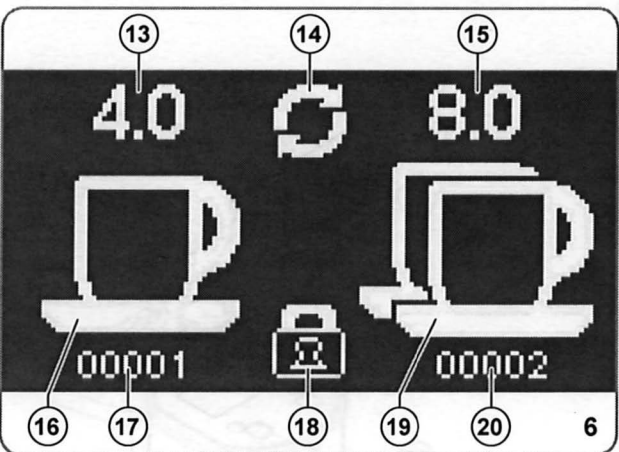
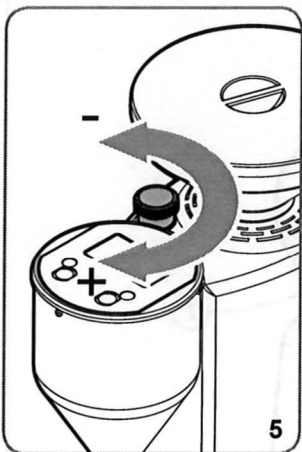
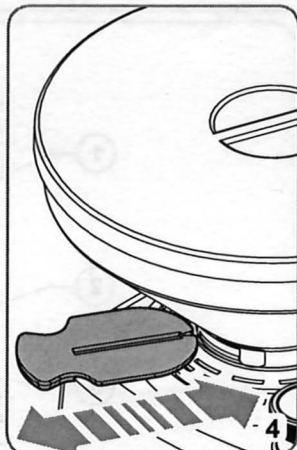
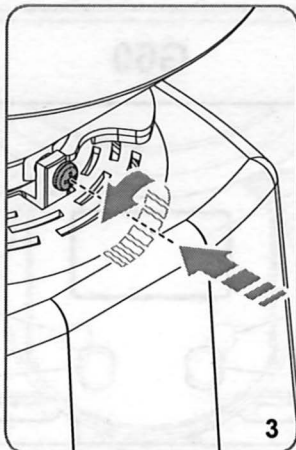
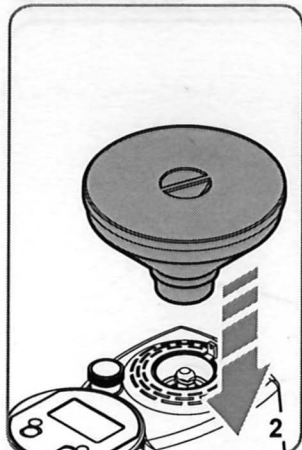





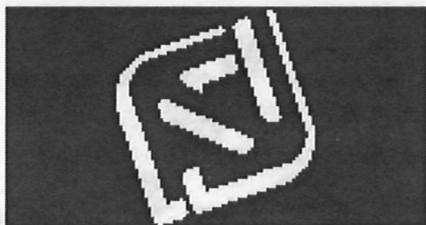

6.4.1 APPLIANCE SWITCH-ON

-  When switching the appliance on for the first time, it is configured in the mode set by the factory and anyway, in the following uses, it will maintain the last mode previous to switch off.

When switching the appliance on, the following screen is shown for 7.5 seconds.



6.4.2 DOSE DISPENSING AND SETTING (DISPLAY)

- Pressing the one dose key (3)  or two doses (5) , the button lights up and the cup (16) or (19) is filled during dispensing.
- Selecting the non-active dose (off key) the grinder will not start immediately; select it again.
- The counter single or double dose, depending on the selection, is incremented by 1.
- If during dispensing you press the one dose button (3)  or two doses (5) , depending of the current dispensing, set the machine to PAUSE mode. The pressed key starts blinking slowly. Pressing the same button for a short time, shooting dispensing; Holding down for a few seconds will cancel the dispensing.
- By pressing the increasing key (4)  and decreasing one (2)  the dispensing time of the properly selected dose is increased or decreased.

6.4.3 CONTINUOUS DISPENSING MODE ACTIVATION

By pressing both keys (3)  and (5)  the continuous mode is activated.



Both dose keys light up and the continuous dispensing symbol appears (14) .

By pressing one of the keys (3)  or (5)  you return to the automatic mode of dose selection.



6.4.4 DOSE COUNTER ZEROING

By pressing both keys (4)  and (2)  for more than 5 seconds, both dose counters are reset (17-20).

6.4.5 FUNCTION BLOCK

By pressing both keys (4)  and (2)  and releasing them, all functions are blocked except the dose selection and the dispensing start.



Furthermore, display shows the symbol (18) .

After having pressed the keys (4)  and (2) , when releasing them, all functions stop.

6.4.6 APPLIANCE SWITCH ON WITH CONCEALED CONTENTS

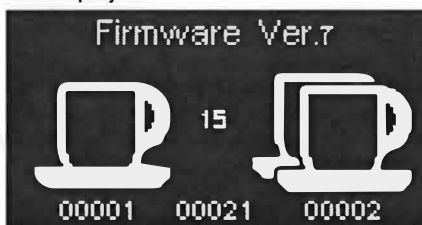
If the key (3)  is kept pressed, when switching the appliance on, a screen is entered where the following data are displayed:



- Firmware version.
- Pressing the increase (4)  or decrease (2)  buttons, increases or decreases the display contrast value.
- 1 and 2 dose total counter cannot be reset.
- In the middle, the dispensing time counter in continuous mode (in seconds) which cannot be reset.

6.4.7 APPLIANCE DEFAULT VALUE SETTING

If the key (5)  is kept pressed, when switching the appliance on, its values are brought to the preset default ones.

The concealed counters are not reset.

The display appears as the one of appliance switch on (see paragraph 6.4.1).

G60

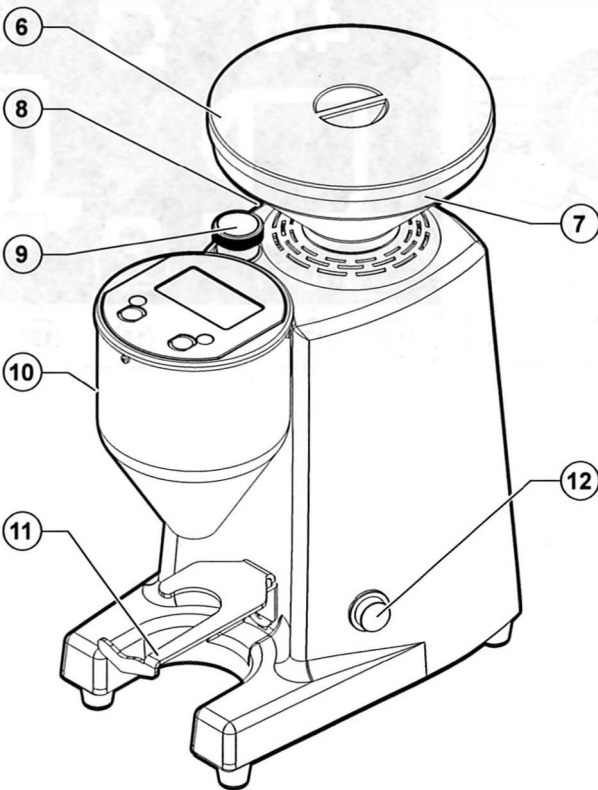
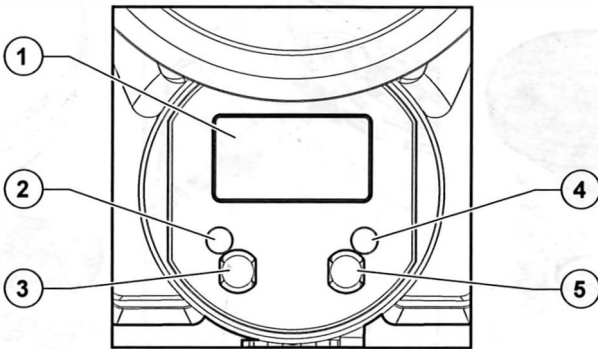



Nuova Distribution Centre
LLC 6940 Salashan PKWY BLDG A
98248 Ferdale, WA
Tel. +1.360.3662226
Fax +1.3603664015
videoconf. +1.360.3188595
www.nuovasimonelli.it
info@nuovasimonelli.com



Via M. d'Antegiano, 6
62020 Belforte del Chienti
Macerata Italy
Tel. +39.0733.9501
Fax +39.0733-950242
www.nuovasimonelli.it
E-mail: n.simonelli@nuovasimonelli.it