



BAKERLUX SPEED.Pro™

USE AND MAINTENANCE (TRANSLATION OF THE ORIGINAL INSTRUCTIONS)





SAFETY **4**

GENERAL INFORMATION..... **10**

USE | BAKE **22**

USE | SPEED..... **48**

SETTINGS..... **66**

MAINTENANCE..... **82**

CONTACTS

Please see the back cover for contacts in your local area.



Dear Customer,

This manual contains all the information you need to use and maintain this appliance correctly.

If you do not fully understand any of the contents, please contact the manufacturer for further information.

Safety

Pictograms 4

Safety information for installing and maintaining the appliance 5

The manufacturer reserves the right to make changes to improve the appliances and accessories at any time without advance notice. Full or partial reproduction of this manual is forbidden without the consent of the manufacturer. The measurements provided are approximate and not binding. In the event of disputes, this document was originally written in Italian. The manufacturer is not responsible for any translation/interpretation errors.

PICTOGRAMS



Read the instruction manual



Danger! Situation presenting immediate danger, or a hazardous situation which could cause injury or death.



Risk of fire!



Risk of electric shock!



Danger: risk of burns



Electromagnetic radiation: do not open compartments marked with this symbol



Tips and useful information



Consult another section



Earthing symbol



Equipotential symbol

SAFETY INFORMATION FOR INSTALLING AND MAINTAINING THE APPLIANCE



General precautions

- Failure to comply with the safety regulations, and any use or maintenance other than those indicated in this manual voids the warranty* and relieves the manufacturer of all liability.
- Keep this appliance out of the reach of children.
- Cleaning and maintenance must be done by the user and NOT by children, especially where not supervised by an adult.
- This appliance can only be used for cooking food in industrial and professional kitchens by qualified personnel, who have completed regular training courses. Any other use is not compliant with the scope of use and is therefore hazardous.
- If the appliance is not working or if you notice any changes to the structure or operation, disconnect the electricity supply and contact an authorised UNOX customer assistance service. Do not attempt to repair the appliance yourself. For any repairs, please request UNOX original spare parts.
- To ensure that the appliance is in perfect condition in terms of use and safety, maintenance and inspections should perform at least yearly by authorised service centre.
- The appliance emits a sound level of below 70 dB.



Risk of burns and injury!

- While cooking and until all appliance parts have cooled, make sure to only touch the appliance control components or handle, because the external parts are extremely hot (temperature above 60°C | 140°F).
- Cooking can only take place with the door closed, for safety reasons. If the door is opened, the oven stops temporarily and a message appears on the display. To resume cooking, simply close the door again.
- In order to maintain optimum performance, do NOT open the door during cooking, especially if you are using the microwave function. If it is not possible to avoid opening the door, please do so very slowly and carefully, paying attention to the hot steam coming out of the oven cavity.
- Wear appropriate protective thermal clothing and take great care when moving containers, accessories and other objects inside the oven cavity.
- NEVER put any type of baking tray, hot or cold container, or other objects on top of the oven, even if it is turned off. DO NOT put highly flammable or heat-sensitive objects (e.g. plastic ornaments, lighters, etc.) near the appliance.
- Leave at least 10 cm | 3.94" of free space around the oven.
- The first time you use the appliance, some of the oils used for manufacturing may evaporate and produce

fumes or unpleasant odours. These will gradually disappear as you continue to use the appliance.

- Liquids or other foods should not be reheated in sealed containers, as these may explode.
- To avoid burns, do not use containers filled with liquids or products that liquefy, heating up to higher levels than can be easily observed (Europe: IEC 60335-2-42: 2002 / AMD1: 2008)
- If reheating beverages, these may reach boiling point and cause a delayed eruption. Be careful when handling the container.
- The contents of any baby bottles and any baby food in jars must be mixed or shaken before consumption. Check the temperature to avoid scalding.
- Only use utensils and containers that are appropriate for the chosen cooking mode (quick or traditional).
- Microwave reheating eggs in their shells or whole boiled eggs could lead to a risk of explosion, even when reheating has finished.



Precautions To Avoid Possible Exposure To Excessive Microwave Energy

- Do not attempt to operate this oven with the door open since open-door operation can result in harmful exposure to microwave energy. It is important not to defeat or tamper with the safety interlocks.
- Do not place any object between the oven front face and the door or allow soil or cleaner residue to accumulate on sealing surfaces.

- Do not operate the oven if it is damaged. It is particularly important that the oven door close properly and that there is no damage to the:
 - Door (bent)
 - hinges and latches (broken or loosened)
 - door seals and sealing surfaces.
- The oven should not be adjusted or repaired by anyone except properly qualified service personnel.



Risk of fire

- Before using the appliance, make sure that there are no non-compliant objects (instruction manuals, plastic bags, etc.) or detergent residues inside the oven cavity. Also make sure that the flue is free of obstructions and that there are no flammable materials in the vicinity.
- When reheating food in plastic or paper containers, check the oven. Risk of fire.
- If you notice any smoke coming from the appliance, disconnect the appliance from the mains power supply and keep the door closed to extinguish any flames.
- Do not place sources of heat (e.g. grills, fryers, etc.), highly flammable substances or fuels (e.g. diesel, petrol, bottles of alcohol, etc.) near the appliance.
- The appliance must be cleaned daily, removing any food residue. Follow the detailed cleaning instructions on page **84**. Failure to carry out cleaning as indicated could cause the surfaces to deteriorate. This could reduce the life of the appliance and cause

danger (if not removed, fats or food residue on the inside could catch fire).

- Do not clean the appliance with a steam or pressurised water jet.
- Do not use highly flammable food or liquids while cooking (e.g. alcohol).
- Clean the oven daily.
- Do NOT clean using flammable detergents or detergents with potentially flammable substances. Only use UNOX SPRAY&Rinse or warm soapy water.



Risk of electric shock!

- Do not open the compartments marked with these symbols. Only qualified personnel authorised by UNOX may access these compartments. Failure to observe this regulation invalidates the warranty* and may cause damage or injury including death.
- Any routine maintenance procedure must be performed:
 - after disconnecting the appliance from the power supply and waiting for the capacitive components to discharge (approx. a few minutes);
 - after waiting for the appliance to cool down fully;
 - only if you are in good mental and physical condition, and are wearing suitable personal protective equipment (e.g. heat-resistant rubber gloves, eye protection, dust mask (optional), etc.).

General information

General information	10
USB port	13
Suggestions and warnings	12
LCD control panel	16
How to set values	18
UIP technologies (UNOX Intelligent Performance)	19

GENERAL INFORMATION

This appliance combines two advanced technologies, which coexist in this versatile and multifunctional product that allows you to exploit different heat-transmission principles: **forced convection**, **microwave** and **conduction**.

Cooking can be performed in two modes:

- **BAKE** ▶ p. 22 | Useful for cooking and browning baked goods.

⊕ Traditional cooking, which uses the heat generated by the heating elements in the oven. For this reason cooking is mainly by **convection** and by **conduction**; it starts from the surface of the food and proceeds progressively through to the core. In **BAKE** mode, however, you can also use the power of the **microwave** (you can adjust this as a percentage) to speed up the cooking processes.

- **SPEED** ▶ p. 48 | Useful for heating food quickly.

⊕ Cooking obtained mainly with **microwaves** i.e. electromagnetic fields that interact directly with the molecules in the food to be cooked. This makes cooking much faster as the energy is

transmitted directly to the food, without heating the containers, as happens in a traditional oven; the heat generated by the heating elements (**forced convection**) also makes the products crispy.

To achieve the best results in SPEED mode, use the SPEED.Plate trays and SPEED.Grid racks, designed specifically for this cooking mode. SPEED.Plate trays are made entirely of 7 mm thick aluminium. They must be preheated in the oven to accumulate as much heat as possible which is then transferred to the dishes to be cooked (**conduction**).

Microwaves are absorbed more efficiently by water molecules in a liquid state and, to a lesser extent, by fats and sugars.

SUGGESTIONS AND WARNINGS

- When using the UNOX racks and baking trays, try to arrange food uniformly and avoid overlapping foods or overloading them (maximum of 4,5 kg | 10 lbs per tray).
- Distribute the trays evenly over the entire height of the oven cavity, respecting the maximum number indicated:

▶ **BAKE** - maximum of 3 trays

▶ **SPEED** - maximum of 1 tray or 1 rack.

If cooking by microwave, the SPEED.Plate trays and SPEED.Grid racks, designed specifically for this cooking mode, must be used. The SPEED.Plate tray, supplied with the appliance, is made entirely of 7 mm thick aluminium; it must be preheated in the oven to accumulate as much heat as possible, which will then be transferred by conduction to the dishes to be cooked. SPEED.Grid racks, if required, must be purchased separately. Please visit our website to learn about all the available SPEED.Pro accessories.

- Avoid seasoning foods directly in the oven cavity; if this cannot be avoided, clean the oven as soon as possible after cooking.
- Do not use highly flammable food or liquids while cooking (e.g. alcohol or wine).
- When cooking in BAKE mode, we recommend preheating the oven to compensate for the heat lost when opening the door; if SMART. Preheating is active, preheating will be managed automatically by the appliance (for further information, see p. 19). If you prefer manual preheating, we recommend setting the temperature to at least 30°C (86°F) higher than the temperature required for cooking.
- In order to maintain optimum performance, **do NOT open the door during cooking, especially if you are using the microwave function**. If it is not possible to avoid opening the door, please do so very slowly and carefully, paying attention to the hot steam coming out of the oven cavity.

- Beware of touching the external and internal parts of the oven during cooking and until it has completely cooled (it could reach temperatures above 60°C | 140°F).
- Liquids or food that liquefy with heat should be placed in containers of adequate capacity so that they do not overflow during cooking, should they boil and erupt.

USB PORT

01 ▶ The USB port is located below the LCD panel and allows you to import or export materials from your own USB stick (FT32 formatted and with capacity between 4 and 16 GB).

To manage the key, see chap. ▶ **Settings** on p. **66**.

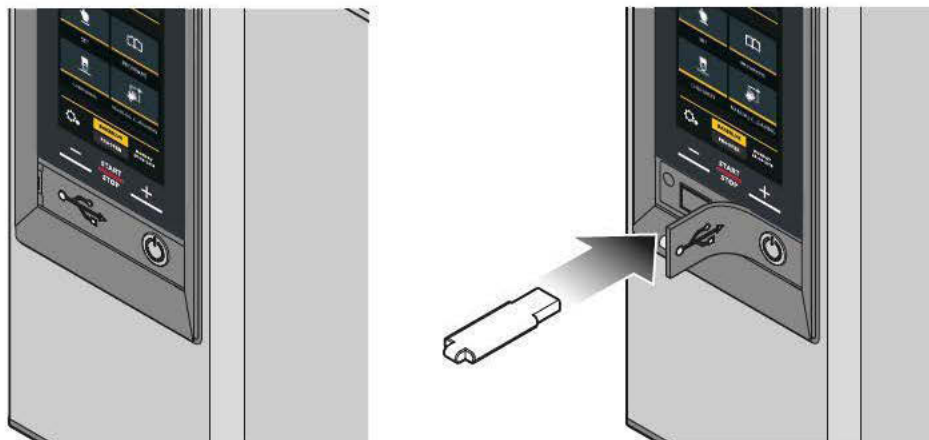

FIRST START-UP

02 ▶ Before switching the appliance on, make sure all protective films have been removed from the appliance: clean any glue residue with appropriate solvents without using tools, abrasive detergents or acids that could ruin the surfaces.

 The removed film, given its potential danger, must be kept out of reach of children and animals; and correctly disposed of in compliance with local regulations.

05 ▶ Also check that the required stickers and labels have been applied:

- yellow sticker “Falling liquid hazard”;
- “Microwave warnings” label;

Both labels must be applied to the appliance, in a position clearly visible to the operators, making sure that any other equipment or objects cannot hide them permanently or temporarily.

Make sure that there are no non-compliant objects inside the oven chamber and clean it as indicated on page **84**. Then connect the appliance plug to a plug of type and load adequate to the maximum power absorbed by the oven’s phases (data available on the attached “Technical specifications” sheet).

ONLY U.S.A. and Canadian markets

04 ▶ On first start-up, the appliance checks **automatically** the rated voltage of the connection system (208V or 240V) and asks for confirmation in a screen.

05 ▶ If it is not detectable or if the oven is connected to a different voltage than when it was last switched on, you are asked to set the correct value, choosing it between 208V-60Hz or 240V-60Hz.

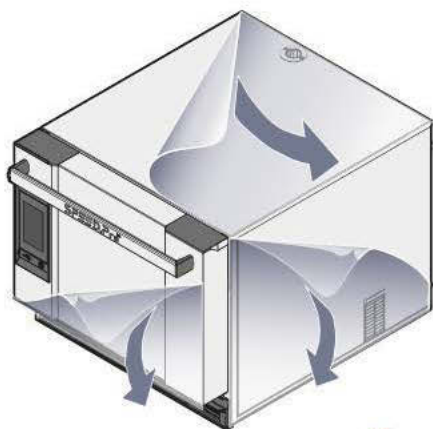

02

- WARNING: Liquids or other foods must not be heated in sealed container since they are liable to explode.
 - WARNING: Microwave heating of beverages can result in delayed eruptive boiling, therefore care must be taken when handling the container.
 - WARNING: The contents of feeding bottles and baby food jars must be stirred or shaken and the temperature checked before consumption, in order to avoid burns.

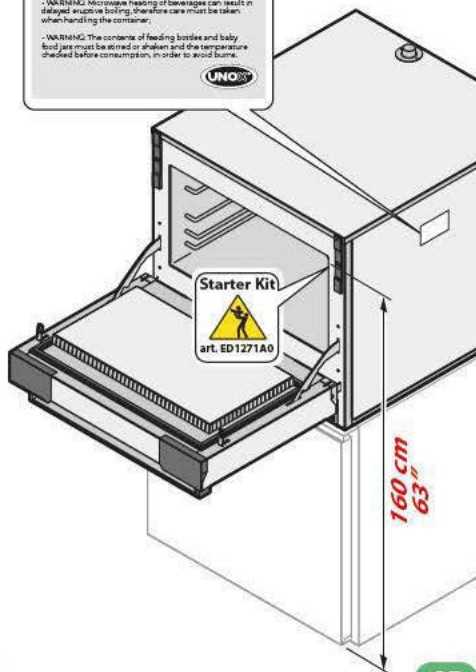

05



the screen asks you to CONFIRM the system voltage that the appliance has detected automatically.

03



the appliance cannot automatically detect the voltage and therefore asks you to SET it.

04

LCD CONTROL PANEL

The relative screen of the cooking mode in use when the appliance was switched OFF will be displayed once again when it is powered ON.

To switch to a different mode, press the corresponding icon:

- **BAKE** ▶ activates BAKE mode (traditional cooking)
- **SPEED** ▶ activates SPEED mode (quick cooking)

The colour of the screen indicates the selected mode:

- yellow screens ▶ indicate BAKE mode (traditional cooking)
- green screens ▶ indicate SPEED mode (quick cooking)

BAKE



SET ▶ p. 23 | This allows cooking cycles in which the parameters must be set manually for each cycle (e.g. temperature, cooking time, etc.).



PROGRAMS ▶ p. 42 | This provides access to a list of cooking cycles stored previously using "SET".



CHEFUNOX ▶ p. 45 | the menu offers a series of recipes pre-set by UNOX: perfect results, guaranteed!



MANUAL WASHING ▶ p. 84 | guided procedure to clean the oven chamber manually.

SPEED



SET ▶ p. 52 | This allows cooking cycles in which the parameters must be set manually for each cycle (e.g. temperature, cooking time, etc.).



PROGRAMS ▶ p. 62 | This provides access to a list of cooking cycles stored previously using "SET".



SPEEDUNOX ▶ p. 63 | the menu offers a series of automatic recipes pre-set by UNOX: the certainty of a perfect result.



MANUAL WASHING ▶ p. 84 | guided procedure to clean the oven chamber manually.

HOME screen

Go back to the main screen

This lets you display all the recipes that have been previously marked as a favourite

The buttons switch from BAKE mode (traditional cooking) to SPEED mode (quick cooking)

Actual temperature/set temperature





Return to the previous page

With a single control panel, it is also possible to control any prover which may be connected. To use the proofer, press the lower icon (PROOF-ER)



The **START STOP** button starts/interrupts cooking

Access to USER, SERVICE, NETWORK and DDC STATS SETTINGS menus
 ▶ chap. "Settings" on p. 66

WI-FI (optional)		ETHERNET	
Active	Not active	Active	Not active
			

HOW TO SET VALUES

07 ▶ Drag the cursor

- ① Tap the symbol of the parameter to be set; this then changes colour (in the case of the “duration” parameter, tap hours, minutes or seconds separately).
- ② Tap the horizontal bar (this lights up) and drag the slider to the desired value; after three seconds of inactivity, the slider bar disappears.

08 ▶ Buttons

- ① Tap the symbol of the parameter to be set; this then changes colour (in the case of the “duration” parameter, tap hours, minutes or seconds separately).
- ② Use the **-** **+** buttons to modify the value.

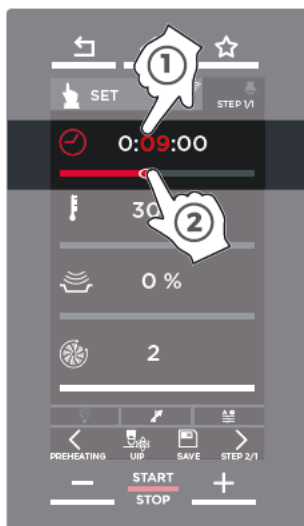

07

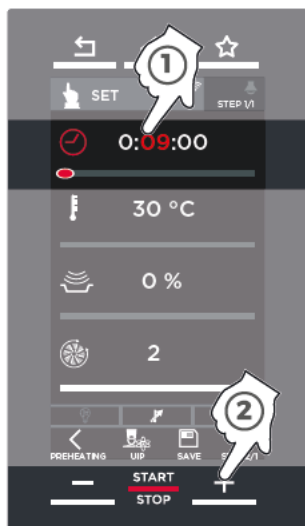

08

UIP TECHNOLOGIES (UNOX INTELLIGENT PERFORMANCE)

09 ▶ If activated, the UIP technologies allow the operator to constantly monitor each preheating and cooking process during manual cooking.

Thanks to this feature, the oven software is able to make **changes** to the user settings autonomously, where necessary, without the operator needing to intervene. This guarantees perfect results every time.

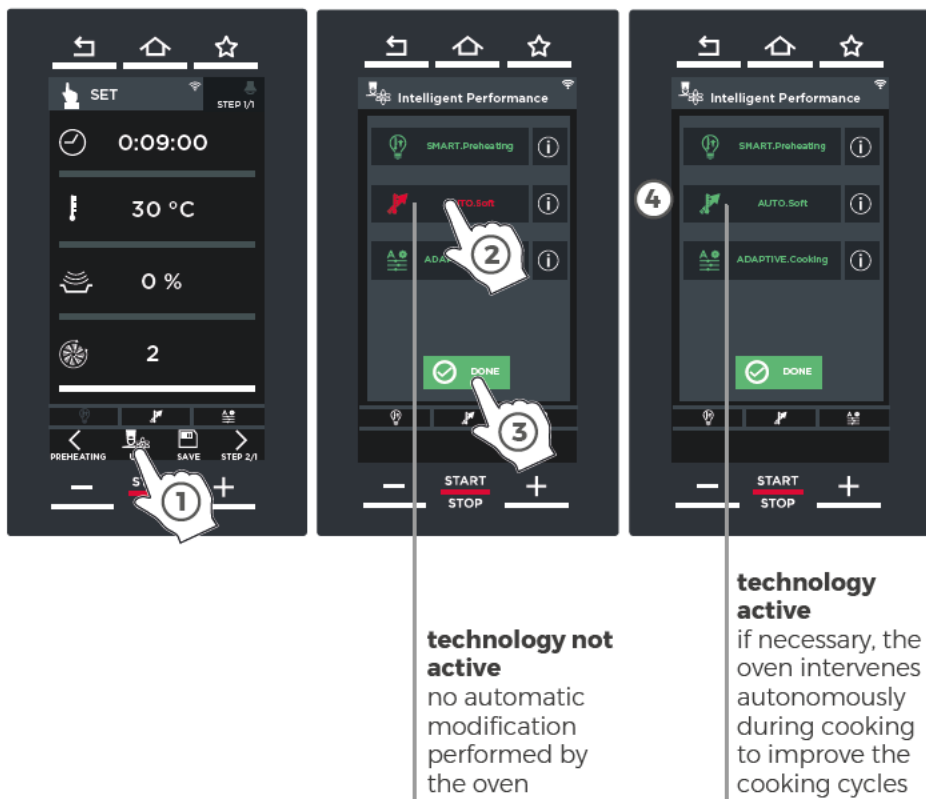

The following UIP technologies are available:

 **SMART.Preheating** ▶ if activated, automatically adjusts the **preheating time and temperature** cycle time, to guarantee uniform cooking and energy efficiency.

 **AUTO.Soft** ▶ if activated, automatically adjusts the **temperature increase speed** to improve cooking uniformity when cooking delicate foods.

 **ADAPTIVE.Cooking** ▶ if activated, this function automatically optimises **all the cooking process parameters** according to the oven load, the time the door is open, and the readings from the oven sensors.



When this key is pressed, information on the corresponding UIP technology is displayed

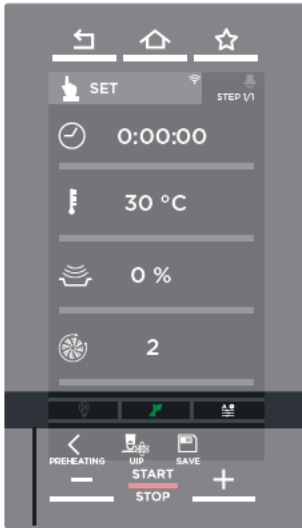

During a cooking cycle, the icons in the lower part of the oven provide useful information about UIP technologies

			<p>GREY ICON ▶ the corresponding UIP function has NOT been activated and will not intervene to improve the cooking cycle</p>
			<p>GREEN ICON ▶ the corresponding UIP function has been activated and is currently in operation for this cooking cycle</p>
			<p>WHITE ICON ▶ the corresponding UIP function has been activated and is currently NOT in operation for this cooking cycle</p>

Use | Bake

traditional cooking

SET 23

PROGRAMS 42

CHEFUNOX 45

06 ▶ The **BAKE** mode makes it possible to perform traditional cooking using the heat generated by the heating elements. This is indicated for bakery products that require long cooking times and to brown their surface. If necessary, to speed up the cooking process, **microwaves can be added to the heat of the heating elements**. You can adjust them as a percentage (20% - 30% recommended). Cooking can be performed as follows:



in manual mode (SET)

▶ p. **23** You must set all cooking parameters;



using previously saved recipes (PROGRAMS)

▶ p. **42** you can access a list of previously saved recipes and start the one that best meets your needs;



with automatic pre-set recipes (CHEFUNOX)

▶ p. **45** you can access a list of automatic recipes already pre-set by UNOX and start the one that best meets your needs.



SET | manual cooking

How to access

In this section, you will find information on:

- what is a manual cooking cycle ▶ p. 24
- how to set parameters ▶ p. 28
- how to start without saving ▶ p. 31
- how to start after saving ▶ p. 32
- what happens at the end of the cooking cycle ▶ p. 41



12 ▶ If the SPEED mode screen appears when the appliance is powered ON (quick cooking), then this was the last mode in use when the appliance was powered OFF.

To switch to BAKE mode (traditional cooking), tap the corresponding icon **BAKE**

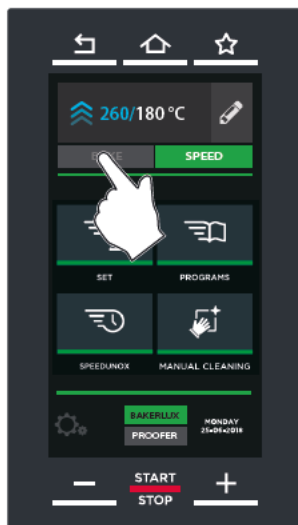

What is a manual cooking cycle

For manual cooking, based on experience, you must set the following parameters for preheating and each cooking step:



cooking time

how long the preheating or cooking cycle should last
(in hours : minutes : seconds)



oven cavity temperature

(°C or °F based on settings)



percentage of microwave use

0 | microwave not used

100 | maximum use of the microwave



fan speed

1 | low speed, recommended for delicate cooking cycles

2 | maximum speed



UIP technologies

► For more details, see p. 19

Each manual cooking cycle is always composed of:

- ► p. 26 | an automatic **preheating**, manual setting or SMART. Preheating cycle (recommended mode);
- ► p. 28 | **up to nine steps** for cooking, each with its own cooking parameters. The appliance automatically passes from one cooking step to the next, if present. Here is an example:

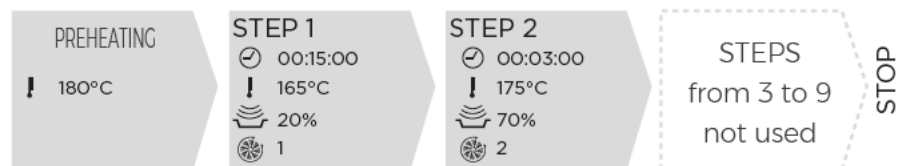

After having set all the parameters (time, temperature, etc.), it is possible to **directly start cooking without saving** ► p. 31 or **save the recipe and then start the cooking cycle** ► p. 32.

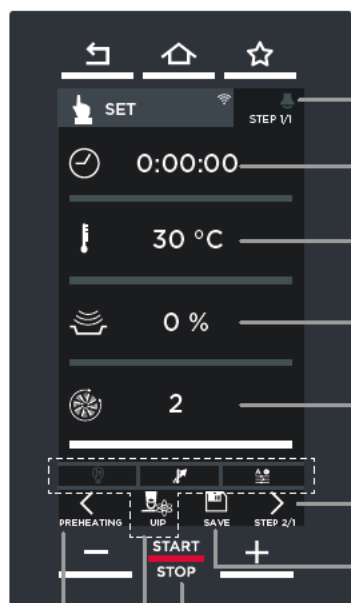

By activating the MULTI.Product function, at the end of the step, an image and a note entered by the user will be displayed (e.g. "add oil").

► For more details, see p. 19

duration of the cooking cycle (hours : minutes : seconds)

temperature in the oven cavity

percentage of microwave use

fan speed

access the settings of the steps following those which are displayed

save a cooking cycle after setting its parameters or after the cycle ends

Start the set cooking cycle

UIP technologies

► For more details, see p. 19

access the preheating settings or go back to the previous step

Preheating

Most cooking requires preheating which is optional but is always recommended to achieve the best cooking results.

Preheating can be set in two ways:

- using UIP technology and activating **SMART.Preheating** (recommended mode) ▶ preheating is managed by the appliance automatically;
- in **manual mode** ▶ the preheating temperature must be set manually.

Once the cooking cycle has been started and regardless of the mode selected, it is possible to interrupt the preheating stage at any time (if needed) and move to STEP 1 ▶ **p. 36**

14 ▶ Setting preheating in manual mode

- ① Tap the “PREHEATING” icon: the settings screen appears.
- ② Set the preheating parameters:
 - **time** ▶ if a time is entered, once the set temperature is reached, the oven holds the temperature for the time set rather than starting the next step (STEP 1);
 - **temperature** ▶ it is always better to preheat the oven to a temperature at least 30-50°C (86°F - 122°F) higher than the temperature required for cooking, in order to reduce the effects of heat lost when opening the door.
- ③ Go to the settings for STEP 1. To enable use, a cooking cycle must contain at least one step.

15 ▶ Activate SMART.Preheating (recommended mode)

By activating the SMART.Preheating function, preheating is managed by the appliance automatically ▶ For more details on UIP technology, see p. **19**.

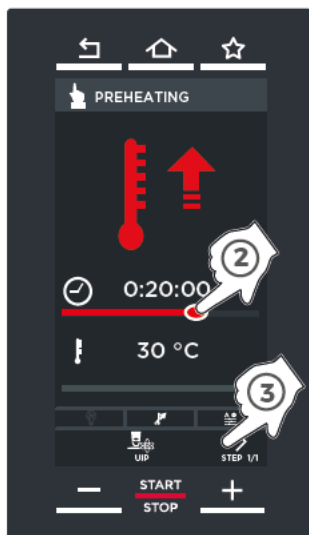
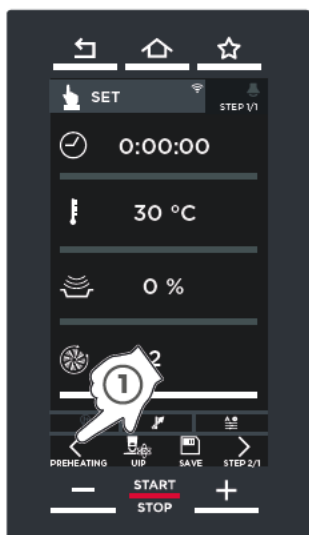

14 Manual preheating



15 SMART.Preheating

Setting and starting the cooking cycle

16 ▶ Set one or more than one cooking steps

- ① Set the cooking parameters of step 1 as required:
 - **cooking time**
 - **temperature**
 - **percentage** of microwave use
 - **fan speed**
 - **function** MULTI.Product ▶ For more details, see p. 19.
- ② For perfect results every time, you can use UIP technology ▶ for details go to p. 19 or enter notes (e.g. add oil) at the end of the set steps ▶ p. 30.
- ③ If necessary, set up to nine other cooking steps in the same way. Each can be characterised by different cooking parameters. The appliance automatically passes from one cooking step to the next, if present.

After having set all the parameters (time, temperature, etc.), you can:

- **start the cooking cycle directly without saving it** ▶ p. 31
in this case the parameters set are not saved and must be entered during each subsequent cooking cycle;
- **save the set recipe and then start a cooking cycle** ▶ p. 32
this means that the recipe can be used later, at any time, without having to reset the parameters each time.

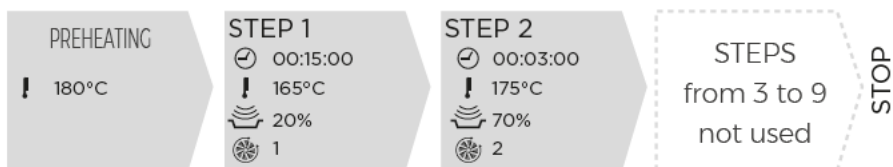
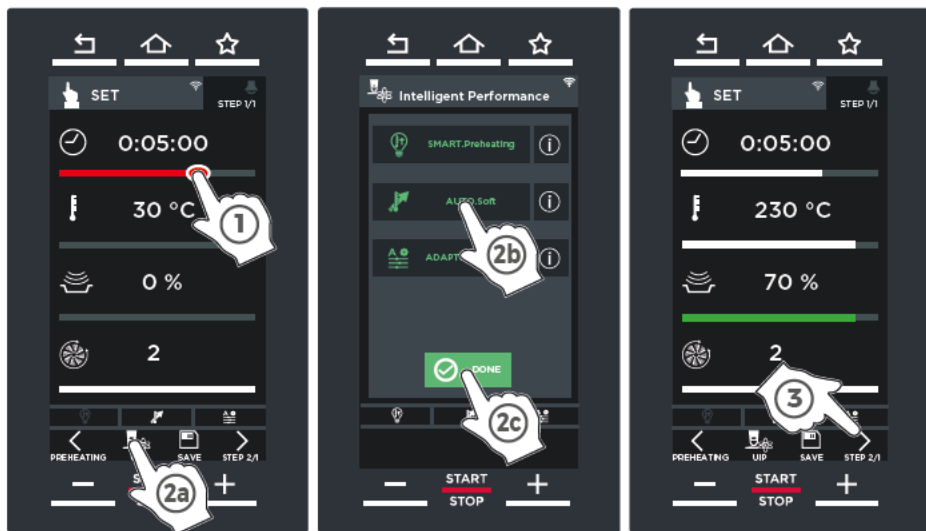

example of setting the parameters

A | Parameters range

Duration	from 0 to 9 hours, 59 minutes, 59 seconds; after this value, if you continue to press + , the oven will switch to "INFINITE" mode (continuous oven operation).
Temperature	from 30°C to 260°C (from 86°F to 500°F)
Microwave	from 0 (microwave not used) to 100%
Fans	1 low speed, recommended for delicate cooking cycles 2 maximum speed

B | MULTI.Product



The MULTI.Product function lets you select a **photo** and write a **note** which will appear at the end of the step for which the function has been activated.

- ① By using the arrows \leftarrow and \rightarrow you can see the step at the end of which you want the screen with the note to be displayed (e.g. STEP 1). Tap the white icon.
- ② ③ Select the photo you want to appear.
- ④ ⑤ ⑥ Write the note, e.g. "Add oil".
- ⑦ Confirm with "OK".
- ⑧ The icon will now turn green indicating that the function is active for STEP 1.
- ⑨ At the end of STEP 1, the set screen will appear.

Starting the cooking cycle directly without saving it

17 ▶ To start the cooking cycle immediately, tap **START STOP**; in this case the parameters set are not saved and must be entered during each subsequent cooking cycle.

Then go to p. 35.

+ At the end of the set time, the recipe can be saved by pressing "SAVE", see fig. ▶ 17.

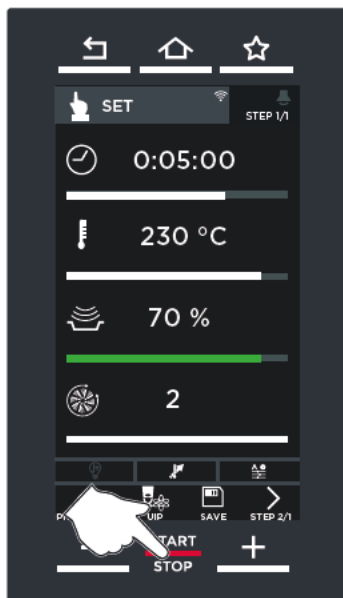

17

C | Further information

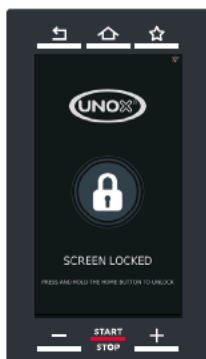

Screen locked

If the oven door is opened, the screen to the side indicates that it is not possible to use the display for safety reasons.



When the door is closed or after pressing and holding the "HOME" button, the screen can be used again.

To deactivate the lock, access the USER SETTINGS menu (see p. 73).

Save and start the set cooking cycle

Saving a cooking cycle means that it can be used later, at any time, without having to reset the parameters each time.

The cooking cycle can be saved:

- **immediately after having set the cooking parameters** (time, temperature, etc.). In this case, you can start it by pressing ;
- **at the end of the cooking cycle**, by pressing “SAVE”, see fig. .

 ▶ To save the recipe which has just been set:

① press “SAVE”.

 ▶ The screen will show:

② assign **a name** to the recipe (e.g. CROISSANT);





③ assign **a photo** to the recipe, selecting from those available;

④ assign **a tray** to the recipe, selecting from those available;

⑤ Press “SAVE” per save a cooking cycle with the set parameters (name, photo, etc);

⑥ tap the **position** where you want to save the cooking cycle (e.g. under “BEIGNET”). If a position already occupied is selected, the program requests authorisation to overwrite the recipe.

At the bottom of the screen:

- the arrows  and  are used to scroll through the 16 **groups** available;
- the arrows  and  are used to scroll through the 16 **positions** available in the group.

The cooking cycle will be saved with the settings entered. To start the cooking cycle later, go to the PROGRAMS menu ▶ p. **42**

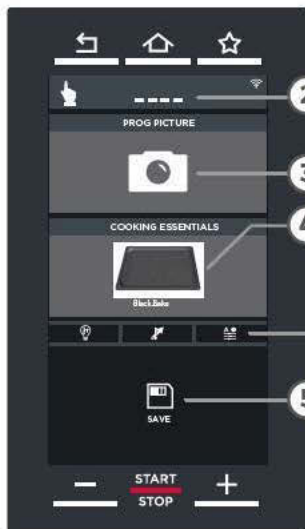
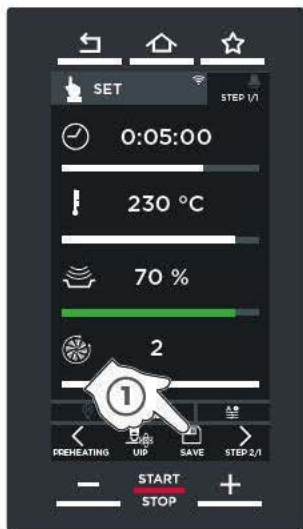

Name of the recipe

Photo assigned

Tray assigned

UIP Technology assigned during the parameter setting stage

Save the settings

18



Assign a **name** to the recipe



Assign a **photo** to the recipe



Assign a **tray** to the recipe



Save the settings



Assign a **position** for the recipe



The recipe has been saved correctly

19

19 Tap one of the cooking cycles listed to open the screen that enables you to:

- 1 **display/modify** the parameters of the saved cooking cycle;
- 2 **copy** the cooking cycle (to create one with similar parameters);
- 3 **delete** a saved cooking cycle: in this case the system requests confirmation before permanently deleting the item;
- 4 **start** a cooking cycle with the **START STOP** button. Then go to p. 35.

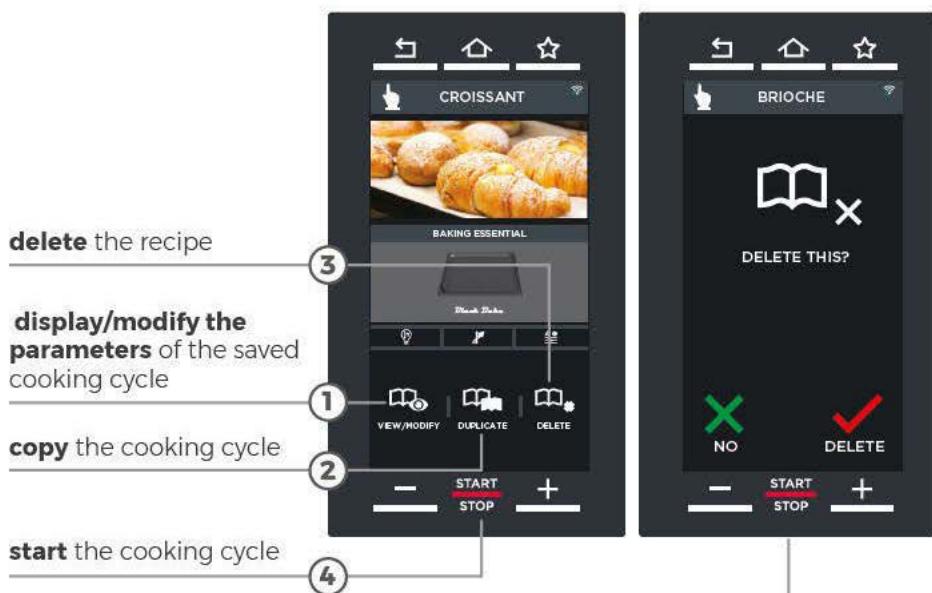

if you decide to delete the recipe (3) DELETE, a screen will request confirmation before permanently deleting the item

What happens after a cooking cycle is started?

After starting a cooking cycle, there are three possible situations depending on the settings which have been entered previously:

- ▶ p. 35 | **preheating or cooling of the cavity not required;**
- ▶ p. 36 | **automatic or manual preheating, or SMART.Preheating starts;**
- ▶ p. 38 | **cavity cooling starts.**

21 ▶ Preheating or cooling of the cavity not required

If the oven is already at the optimum temperature for the set or selected program at the start of a cooking cycle, the oven will not preheat or cool the cavity. Instead, a screen will appear to the side prompting you to put the dishes in the oven directly.

After this operation, when the oven door is closed, the relevant steps automatically start

▶ p. 40.

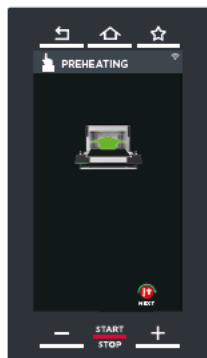

BAKE mode

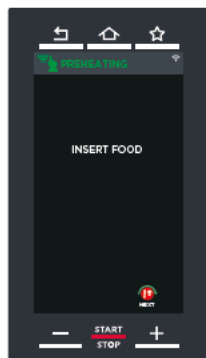

SPEED mode

22 ▶ Automatic or manual preheating, or SMART.Preheating

Preheating always starts if the oven cavity is at a lower temperature than the temperature set for the first step of the cooking cycle.

If during the parameter setting phase:



- NEITHER manual NOR SMART.Preheating has been set, **automatic preheating** of the cavity will start in any case and will end when the temperature set for step 1 is reached;
- **manual** preheating has been set or **SMART.Preheating** has been activated, it will end either when the temperature set by the user has been reached (manual preheating) or automatically, when managed by the oven software (SMART.Preheating).

In both cases, do not put the dishes into the oven immediately, but wait until this first step ends. This will be indicated by a buzzer and the relative screen.

After this operation, when the oven door is closed, the relevant steps automatically start ▶ **p. 40**.

⊕ If needed, it is always possible to interrupt a preheating in progress and move directly to the first step; however, once the preheating has been interrupted, it can NOT be reactivated.

To interrupt the preheating function:

- manual ▶ press  SKIP PRE.
- SMART.Preheating ▶ press  to move to manual preheating and then press  to lock it.

⊕ It is NOT possible to change a manual preheating cycle which is in progress with a SMART.Preheating cycle.

▶ automatic or manual preheating function

Estimated time until the end of the preheating added to the total cooking time

Preheating time set. This can be modified directly from the screen

Oven cavity temperature

Set temperature

Access the UIP technology setting ▶ For more details, see p. 19

Skips preheating and starts the cooking cycle immediately

Access to the parameters for the subsequent steps

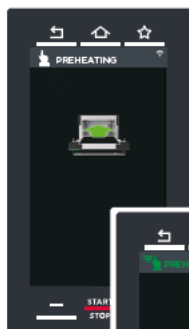
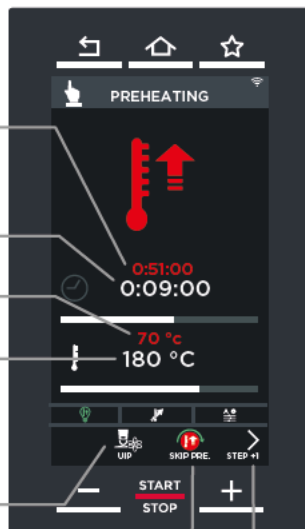

The screen indicates that preheating has completed; put the dishes into the oven.

▶ SMART.Preheating

Oven cavity temperature

Set temperature

Time remaining before the end of preheating (presumed) or progressive percentage

Access the UIP technology setting ▶ For more details, see p. 19

Change from preheating with SMART.Preheating in progress to manual preheating

Access to the parameters for the subsequent steps

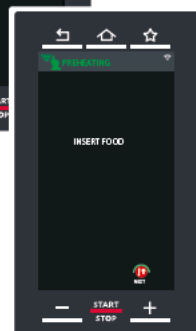
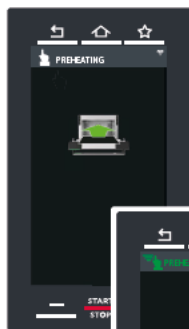
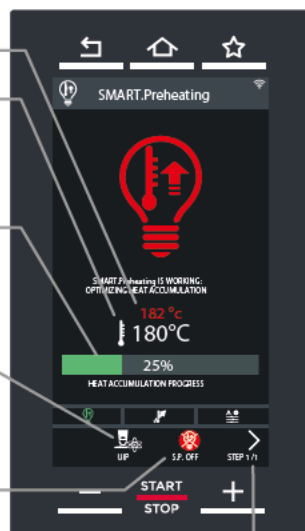

▶ Manual cooling or SMART.Preheating

If the actual temperature detected in the cavity is higher than the set temperature (for example because the oven has recently finished cooking at a much higher temperature than required preheated temperature), the oven will start to cool the cavity using the fans.

To speed up the operation, a screen will prompt you to open the door (it is normal for the fans to continue to operate even when the door is open).

Wait for this to end before putting the food in the oven. After this operation, when the oven door is closed, the relevant steps automatically start ▶ **p. 40.**

▶ manual cooling

Estimated time until the end of the cooling cycle added to the total cooking time

Time remaining until the end of the cooling cycle (estimated)

Oven cavity temperature

Set temperature

Change from the manual cooling in progress to SMART.Preheating

Skip cooling and start the cooking cycle

Access to the parameters for the subsequent steps

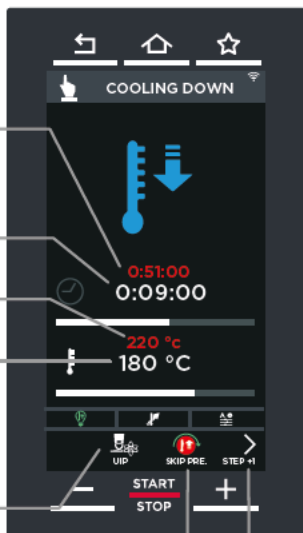

The screen indicates that preheating has completed; put the dishes into the oven.

▶ SMART.Preheating cooling

Oven cavity temperature

Set temperature

Time remaining until the end of the cooling cycle (presumed) or progressive percentage

Access the UIP technology setting

Change from cooling with SMART.Preheating in progress to manual cooling

Access to the parameters for the subsequent steps

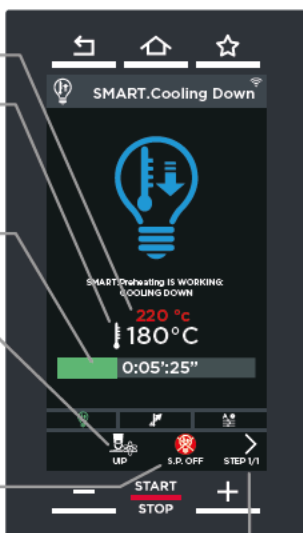

Cooking cycle in progress

24 ► Cooking is in progress. If you want to stop the cooking cycle in progress, hold down the **START/STOP** (approx. 4-5 seconds).

Current cooking cycle time remaining > 15 sec.

Current cooking cycle time remaining < 15 sec.

Cooking complete time remaining < 5 sec.

Tap the centre of the circle to display the cooking end time (in this example, the dishes will be ready at 11:48)

Time remaining until the end of the cooking cycle in progress

Time remaining until the end of the current step

Displays and allows the temporary modification of the parameters of the recipe in progress

From this screen, you can **make temporary changes** to the cooking cycle in progress

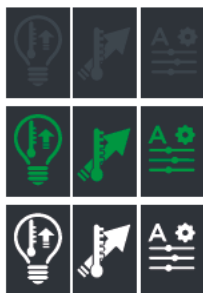

GREY ICON ► the corresponding UIP function has NOT been activated and will not intervene to improve the cooking cycle

GREEN ICON ► the corresponding UIP function has been activated and is currently in operation for this cooking cycle

WHITE ICON ► the corresponding UIP function has been activated and is currently NOT in operation for this cooking cycle

Cooking end

25 ► Cooking ends when the set time interval is reached; the end of cooking is indicated by a long acoustic signal and display of the screen shown in the figure.

From this screen you can:

- ① **save** the completed cooking cycle (if this has not already been done) ► **p. 32**;
- ② **repeat the cooking cycle** as soon as it has finished, modifying the parameters if necessary;
- ③ **repeat the last step** carried out, modifying the parameters if necessary.

If you do not wish to save the cooking cycle, press “HOME” to return to the main page.

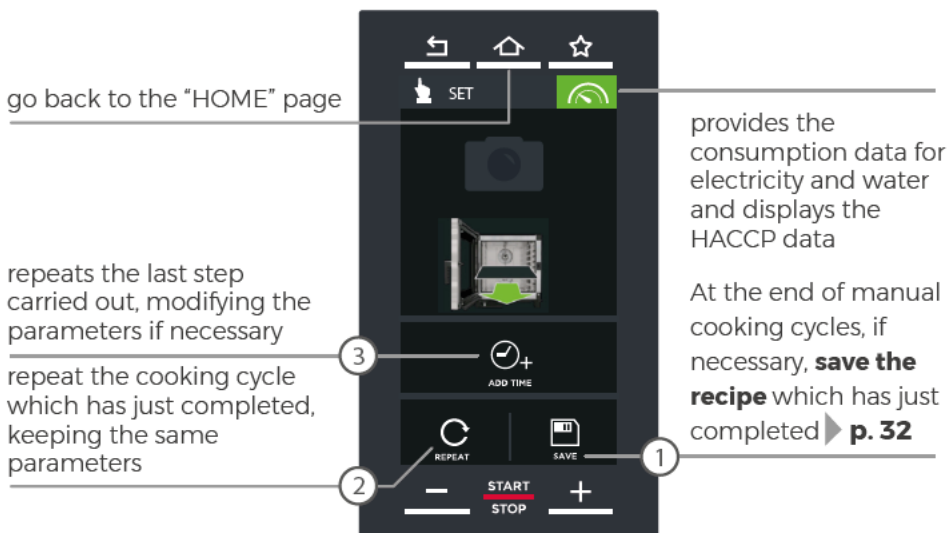



PROGRAMS | saved recipes

How to access

In this section, you will find information on:

- what a saved recipe is
▶ p. 43
- how to call up and start a saved recipe ▶ p. 43
- changing the parameters of a saved recipe ▶ p. 44



display the recipe parameters

copy the recipe

start the recipe

delete the recipe

Saved recipes

You can access a list of previously saved recipes using “SET” and start the one that best meets your needs: this guarantees perfect results every time and avoids having to set parameters at each use.

Call up and start a saved recipe

26 ▶

- ① Tap the icon “PROGRAMS”; the list of previously saved cooking cycles will appear using “SET | manual cooking”.
At the bottom of the screen:
 - the arrows < and > are used to scroll through the 16 **groups** available;
 - the arrows ∨ and ∧ are used to scroll through the **cooking cycles** saved in the group.
- ② Tap one of the recipes in the list (e.g. croissant) to open the screen that allows you to:
 - Ⓐ **display/modify** the parameters of the saved recipe;
 - Ⓑ **duplicate** the recipe (to create one with similar parameters);
 - Ⓒ **delete** a saved recipe: in this case the system requests confirmation before permanently deleting the item;
 - Ⓓ **start** the recipe by pressing the **START STOP** button.
- ③ Once a recipe has been started and depending on the specific parameters, three different displays may be shown on the screen.
 - ▶ p. 43 | **preheating or cooling of the cavity not required** ▶ put the food in the oven immediately;
 - ▶ p. 36 | **automatic or manual preheating, or SMART.Preheating starts** ▶ wait for this to end before putting the food in the oven;
 - ▶ p. 38 | **cavity cooling starts** ▶ wait for this to end before putting the food in the oven.
- ④ When the oven door is closed, the automatic steps of the recipe will start ▶ p. 40.
- ⑤ Cooking ends when the time set for the recipe is reached: this is indicated by an acoustic signal and a screen ▶ with details p. 41

Changing the parameters of a saved recipe

26

- 1 2 Select the recipe you want to modify;
- 3 tap the display/modify parameters icon;
- 4 5 change the parameters as required and as described previously;
- 6 7 save the modifications made; these are permanent and will change the recipe.

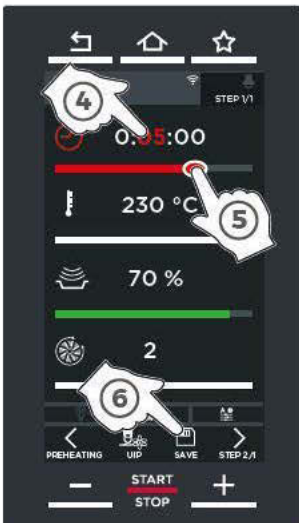

This procedure changes the recipe in the memory permanently. However, changes made during a cooking cycle are temporary, i.e. they only apply to the cooking cycle in progress but do not change the original recipe if saved.



CHEFUNOX automatic recipes

How to access

In this section, you will find information on:

- what a CHEFUNOX automatic recipe is ► p. 45
- how to call up and start a CHEFUNOX automatic recipe ► p. 46



CHEFUNOX automatic recipes



In this section you can find the UNOX pre-set recipes. Simply:

- select the **category** (e.g. FRESH BAKERY)
- select the **food type** to be cooked (e.g. BUN)
- enter the characteristics of the food to be cooked
- start the cooking cycle.

Great results, every time.

Call up and start a CHEFUNOX automatic recipe

27 ▶

- ① Tap the “CHEFUNOX” icon;
- ② select the category to which the food type you wish to cook belongs, choosing from those available:
 - pastries, fresh or frozen;
 - bread, fresh or frozen;
 - snacks, fresh or frozen.
- ③ select the food type to be cooked (e.g. BUNS);
- ④ The oven will ask you to enter data to personalise the cooking cycle (data is not always present in the ones listed, it will depend on the type of food):
 -  **weight** ▶ enter the weight of the food to be cooked in grams
 -  **thickness** ▶ enter the thickness of the food to be cooked in grams
 -  **external degree of cooking**: LIGHT - MEDIUM - BROWN. The external degree of cooking can also be set by dragging the cursor to the desired temperature.
- ⑤ Start the cooking cycle by pressing the **START**/**STOP** button. After starting the cooking cycle, there are three possible situations depending on the recipe settings:
 - ▶ p. 46 | **preheating or cooling of the cavity not required**
 - ▶ put the food in the oven immediately;
 - ▶ p. 36 | **automatic or manual preheating, or SMART.Preheating starts** ▶ wait for this to end before putting the food in the oven;
 - ▶ p. 38 | **cavity cooling starts** ▶ wait for this to end before putting the food in the oven.
- ⑥ When the oven door is closed, the automatic steps of the recipe will start ▶ p. 40.

- ⑦ Cooking ends when the time set for the recipe is reached: this is indicated by an acoustic signal and a screen with details **p. 41**



Use | Speed

fast cooking

SET **52**

PROGRAMS **62**

CHEFUNOX **63**

06 ► **SPEED** mode lets you cook food quickly using **microwaves** and heating elements (**forced convection cooking**). For best results, use the SPEED.Plate tray and the SPEED.Grid grill, designed specifically for this cooking mode. The SPEED.Plate tray, supplied with the appliance, is made entirely of 7 mm thick aluminium; it must be preheated in the oven to accumulate as much heat as possible so that it will then be transferred by conduction to the dishes to be cooked, thereby crisping them up. SPEED.Grid racks, if required, must be purchased separately. Please visit our website to learn about all the available SPEED.Pro accessories.

This is indicated for bakery products that require long cooking times and to re-heat them quickly.

Cooking can be performed as follows:



in manual mode (SET)

▶ p. 52

you must set all cooking parameters;



using previously saved recipes (PROGRAMS)

▶ p. 62

you can access a list of previously saved recipes and start the one that best meet your needs;



with automatic pre-set recipes (SPEEDUNOX)

▶ p. 63



you can access a list of automatic recipes already pre-set by UNOX and start the one that best meet your needs.

Each manual cooking cycle can have **up to nine steps** for cooking, each with its own cooking parameters. The appliance automatically passes from one cooking step to the next, if present.

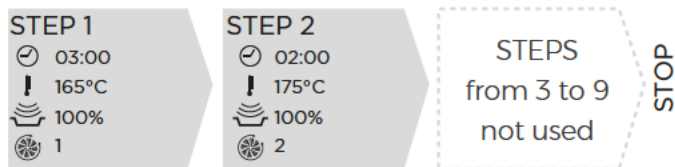
Here is an example:



After having set all the parameters (time, temperature, etc.), it is possible to **directly start cooking without saving** or **save the recipe and then start the cooking**.

- ① If the BAKE mode screen appears when the appliance is powered ON (traditional cooking), then this was the last mode in use when the appliance was powered OFF. To switch to SPEED mode (quick cooking), tap the corresponding icon 
- ② A screen will appear asking you to insert the tray or the rack required to use the microwave (SPEED.Plate or SPEED.Grid).
- ③ Once this has been done, you can confirm using . A screen will appear where you can select the **temperature** that the oven must maintain while waiting for cooking to begin. Each temperature setting is particularly suitable for a specific food type. Tap "INFO" to show information about the foods which can be cooked at the selected temperature. You can prevent this screen from appearing by going to "User settings" ▶ Options ▶ Speed ▶ Pre-set standby temperature, and setting the parameter with a different value that is not "ASK EVERY TIME" ▶ For more details, see p. **75**.
- ④ The screen which appears shows the progressive increase of the temperature (in the example, it is 180°C | 356°F and will increase until it reaches 220°C | 428°F). For the best results, wait for this pre-heating phase to end after which you can put the products into the oven with the tray/rack already heated. You can then select the cooking cycle:
 - in manual mode (SET)** ▶ p. **52**
 - using previously saved recipes (PROGRAMS)** ▶ p. **62**
 - with automatic present recipes (SPEEDUNOX)** ▶ p. **63**

D | Temperature and food

150 °C | 302 °F ▶ regeneration

180 °C | 356 °F ▶ bread | pastries

220 °C | 428 °F ▶ burgers | paninis

260 °C | 500 °F ▶ toasted sandwiches | pizza



an information screen showing which foods are suitable for the selected temperature

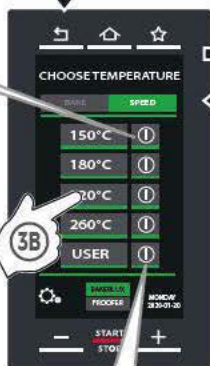

By tapping the "pencil" symbol, this screen will appear

this screen only appears if "Ask every time" has been selected in the user settings menu

If the required temperature is not in the list, you can set the last item "USER" with a personalised value (e.g. 140°C | 284°F) which will be saved.





SET | manual cooking

How to access

In this section, you will find information on:

- what is a manual cooking cycle ► p. 52
- how to set the parameters, how to start without saving and how to start after saving ► p. 31



What is a manual cooking cycle

For manual cooking, based on experience, you must set the following parameters for each cooking step:



Cooking time

how long the preheating or cooking cycle should last (in minutes: seconds - from 0 to 4 minutes and 59 seconds)



Oven cavity temperature



percentage of microwave use

0 | microwave not used
100 | maximum use of the microwave



fan speed



UIP technologies

► for further details, refer to p. 19

After having set all the parameters (time, temperature, etc.), you can:

- **start cooking directly without saving** ▶ in this case the parameters set are not saved and must be entered during each subsequent cooking cycle.
- **save the recipe set and then start cooking** ▶ this means that the recipe can be used later, at any time, without having to reset the parameters each time..



By activating the MULTI.Product function, at the end of the step, an image and a note entered by the user will be displayed (e.g. "add oil")

▶ For more details, see p. 19

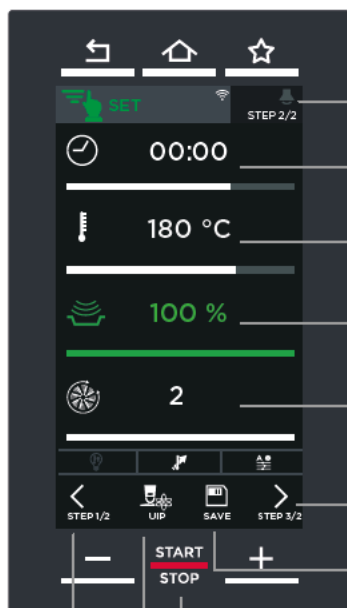

cooking time

oven cavity temperature set previously

percentage of microwave use

fan speed

access the settings of the steps following the first one set

save a cooking cycle after setting its parameters or after the cycle has come to an end

Start the set cooking cycle

UIP technologies

▶ for further details, refer to p. 19

Setting and starting the cooking cycle

32 ▶ Set one or more than one cooking step

- ① Select manual cooking by tapping the “SET” icon.
- ② Set the cooking parameters as required:
 - **cooking time**
 - **temperature** (the oven will suggest the SPEED cooking temperature set previously. However this value can be modified if necessary)
 - **percentage** of microwave use
 - **fan speed**
 - **function** MULTI.Product ▶ For more details, see p. 19
- ③ For perfect results every time, you can use UIP technology
 - ▶ For more details, see p. 19.

Cooking cycle start

After having set all the parameters (time, temperature, etc.), you can:

- **start a cooking cycle directly without saving it**
in this case the parameters set are not saved and must be entered during each subsequent cooking cycle.
 - 33 ▶ To start cooking, tap **START** and continue to p. 58.
- **save the set recipe and then start a cooking cycle** ▶ p. 56
this means that the recipe can be used later, at any time, without having to reset the parameters each time.

The temperature is the one set previously on the STANDBY screen (e.g. 180°C | 356°F); this can be changed if necessary. It is recommended that a range of +/-10°C (+/-50°F) is maintained.



32

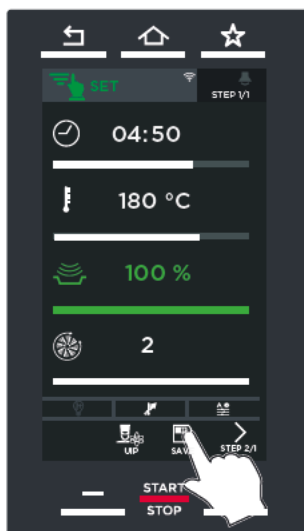

33

Saving a set recipe and starting a cooking cycle

Saving a cooking cycle means that it can be used later, at any time, without having to reset the parameters each time.

34 ▶ To save the recipe which has just been set:

① press "SAVE".

35 ▶ The screen will show:

② assign a **photo** to the recipe, selecting from those available;

③ set **the type of food** (e.g. FRESH SANDWICH);

④ set **the weight** of the food you want to use, choosing from the available options (e.g. 240 g);

⑤ press "SAVE" to save the cooking cycle with the parameters set (name, photo, etc);

⑥ tap the **position** where you want to save the cooking cycle (e.g. under "SPEED MULTI STEP"). If you select a position that is already occupied, the program requests authorisation to overwrite the recipe.

At the bottom of the screen:

- the arrows < and > are used to scroll through the 16 available groups;
- the arrows v and ^ are used to scroll through the 16 positions available in the group.

The cooking cycle will be saved with the settings entered. To start the cooking cycle later, go to the PROGRAMS menu ▶ p. 62

36 ▶ To start the cooking cycle which has just been set, tap the name. If the chosen cooking cycle involves:

- multiple STEPS, tap where it says "1 pcs" (1 piece) ▶ and the recipe will start. Continue to p. 58.
- one STEP, choose how many pieces you want to use (e.g. 2pcs | 2 pieces) ▶ and the recipe will start. Continue to p. 58.

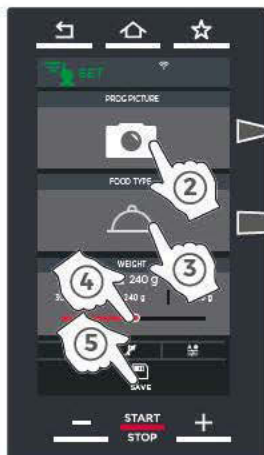
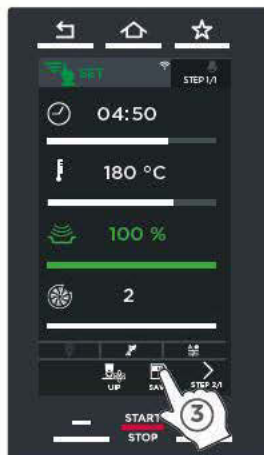

34

35

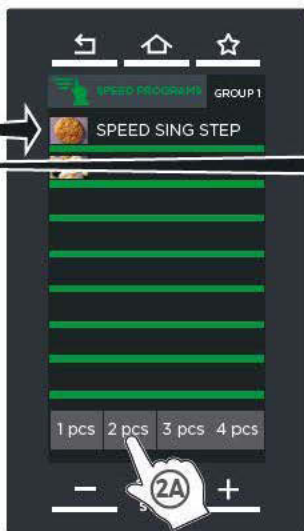

Starting a cooking cycle with **ONE STEP**

Starting a cooking with **MULTIPLE STEPS**

36

Cooking cycle in progress

After pressing the **START**/**STOP** button or one of the portion quantity buttons to be inserted, cooking will start. If you want to stop it early, press and hold the same button for about 4-5 seconds.

After starting a cooking cycle, there are three options, depending on the settings entered previously (for more information see ► p. **35** | N.B. the images shown refer to a BAKE cooking cycle (traditional cooking cycle) but the concept remains the same):

- cavity preheating or cooling not necessary ► put the food in the oven. When the oven door is closed, the relevant steps will start automatically ► **37**
- automatic or manual preheating, or SMART.Preheating starts ► wait for this to end before putting the food in the oven. When the oven door is closed, the relevant steps will start automatically ► **37**
- cavity cooling starts ► wait for this to end before putting the food in the oven. When the oven door is closed, the relevant steps will start automatically ► **37**.

Current cooking cycle time remaining > 15 sec.

Current cooking cycle time remaining < 15 sec.

Cooking complete time remaining < 5 sec.

Time remaining until the end of the cooking cycle in progress

Time remaining until the end of the current step

Display and temporarily modify the parameters of the recipe in progress

Tap the centre of the circle to display the cooking end time (in this example, the dishes will be ready at 11:48)

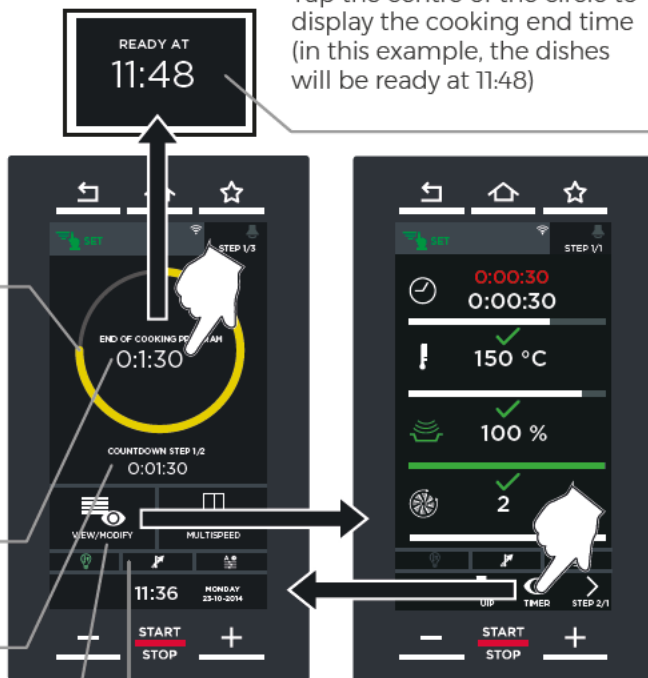

From this screen, you can **make temporary changes** to the cooking cycle in progress



GREY ICON ► the corresponding UIP function has NOT been activated and will not intervene to improve the cooking cycle

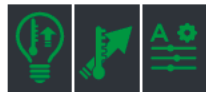

GREEN ICON ► the corresponding UIP function has been activated and is currently in operation for this cooking cycle

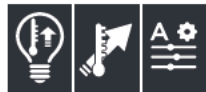

WHITE ICON ► the corresponding UIP function has been activated and is currently NOT in operation for this cooking cycle

E | MULTI.SPEED

Both manual and automatic cooking cycles with only one step can be used to add more food when cooking is already in progress, should additional orders come in. The Speed.pro cooking cavity is capacious and can contain up to 4 products.

- ① In the example, a manual cooking cycle is running. Press the MULTI.SPEED button to add up to 4 additional timers.
- ② Press the "ADD TIME" button to set the desired timers.
- ③ The timers can be set:
 - (A) manually ▶ set the desired time ④ or press the **START STOP** button ⑤
 - (B) by choosing a recipe from the list ▶ set the number of pieces ④ or press the **START STOP** button ⑤. The number of pieces you can select depends on the space available inside the oven cavity.
 - (C) by choosing a Speed.UNOX recipe ▶ set the type of food (in the example, "Muf-

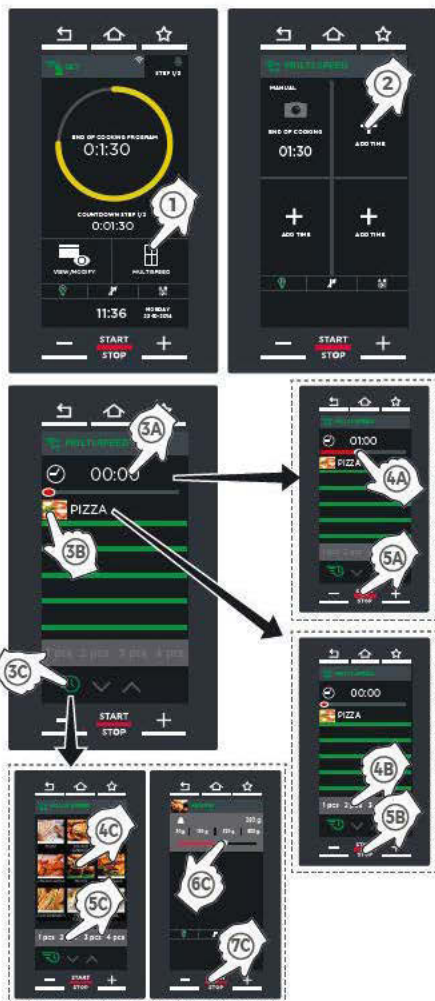

fin") ④, the number of pieces ⑤ and the weight ⑥ press the **START STOP** button ⑦. The number of pieces you can select depends on the space available inside the oven cavity. MULTI.SPEED recipes use UIP technology ▶ for more information on UIP technology, please see p. 19.

39 ▶ If you need to add time during cooking, select the timer you want to change and press the + or - buttons.

40 ▶ When the manually set time or the time in the recipe ends, the display shows that you should remove the food that has finished cooking. When the door is closed, the timers that have not yet finished will resume their countdown. Any free timers can be used again if necessary. Press the "ADD TIME" button.



39

Timer finished

Timer running (recipe)

Timer running (Speed.UNOX recipe)



40



PROGRAMS | saved recipes

You can access a list of previously saved recipes using “SET” and start the one that best meets your needs: this guarantees perfect results every time and avoids having to set parameters at each use.

41 ▶ To start the cooking cycle, tap the name.

If the chosen cooking cycle involves:

- multiple cooking STEPS, tap where it says “1 pcs” (1 piece) ▶ and the recipe will start (for more information, continue to p. 58);
- one cooking STEP, choose how many pieces you want to use (e.g. 2pcs | 2 pieces) ▶ and the recipe will start (for more information, continue to p. 58).

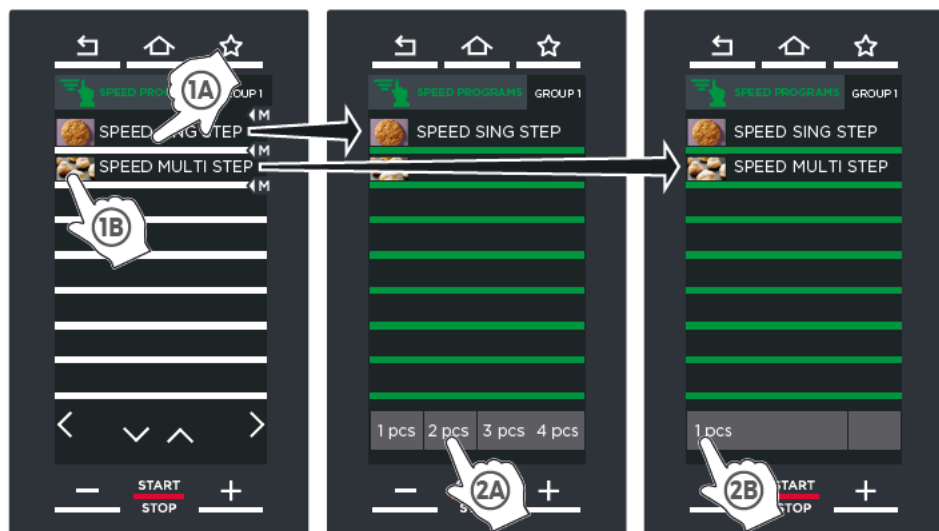

Starting a cooking cycle
with **ONE STEP**

Starting a cooking with
MULTIPLE STEPS



How to access

In this section, you will find information on:

- what a SPEEDUNOX automatic recipe is
▶ p. 63
- how to call up and start a SPEEDUNOX automatic recipe ▶ p. 46



SPEEDUNOX automatic recipes

In this section you can find the UNOX pre-set recipes. Simply:

- select the **type of food** to be cooked (e.g. TOASTED SANDWICH)
- enter number of pieces to be cooked
- start the cooking cycle.

Great results, every time.

Call up and start a SPEEDUNOX automatic recipe

42 ▶

- ① Tap the “SPEEDUNOX” icon;
- ② select the **type of food** to be cooked (e.g. TOASTED SANDWICH);
- ③ Enter the  **number of pieces (pcs)** to be cooked.
- ④ Start the cooking cycle by pressing the **START** button. After starting the cooking cycle, there are three possible situations depending on the recipe settings:
 - ▶ p. **35** | **preheating or cooling of the cavity not required** ▶ put the food in the oven immediately;
 - ▶ p. **36** | **automatic or manual preheating, or SMART.Preheating starts** ▶ wait for this to end before putting the food in the oven;
 - ▶ p. **38** | **cavity cooling starts** ▶ wait for this to end before putting the food in the oven.
- ⑤ When the oven door is closed, the automatic steps of the recipe will start ▶ **p. 40**.
- ⑥ Cooking ends when the time set for the recipe is reached: this is indicated by an acoustic signal and a screen ▶ with details **p. 41**



Settings

User settings	67
Menu service	77
Network	77
DDC Stats	78

43 ▶ From this section you can access the oven parameter settings.

It is divided into 4 sections:

- User settings ▶ p.**67**
- Menu service ▶ p.**77**
- Network ▶ p.**77**
- DDC Stats ▶ p.**78**

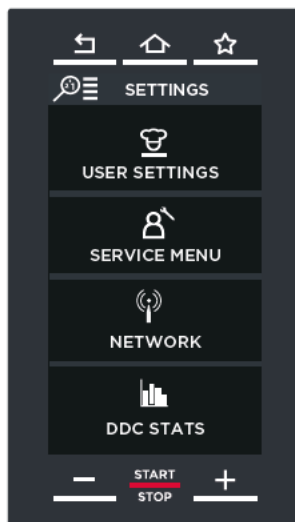
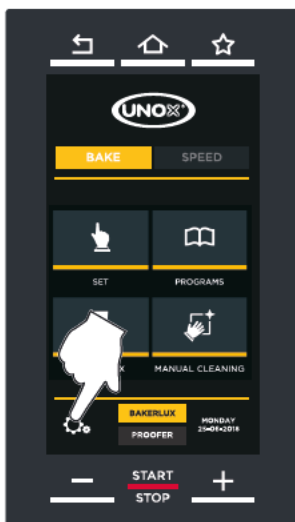

USER SETTINGS

44 ► The “USER SETTINGS” section can be accessed by any user by entering the password “4456” and then confirming with “OK”.

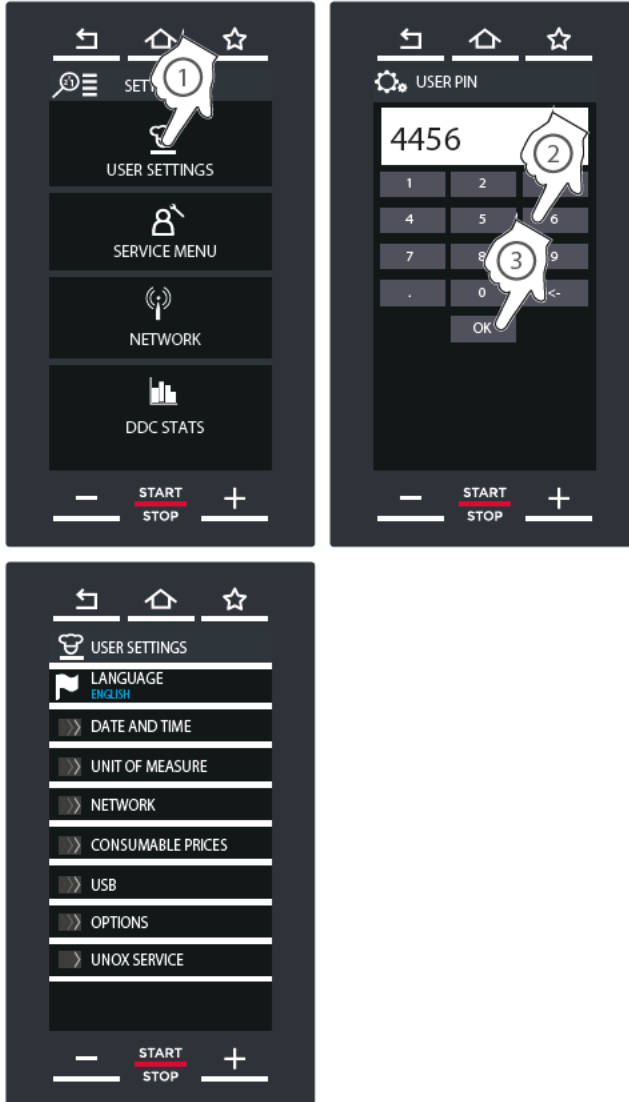

Language

45 ▶ Here you can select the language, which will be used for all menu entries. You can scroll through the list of available languages using the arrows ▼ and ▲.

Simply tap a language to select it.

Date and time

46 ▶ This lets you modify the date and time settings of the menu. It is necessary to:

- set the **Time zone**, clicking on the relevant geographic area and selecting the country, scrolling through the list using the arrows ▼ and ▲;
- enter the current standard clock time as **winter time** (also called standard time) or **summer time** (also called daylight saving time); alternatively, the “AUTOMATIC” setting allows the time to be updated automatically;
- set the current **time, year, month** and **day**.

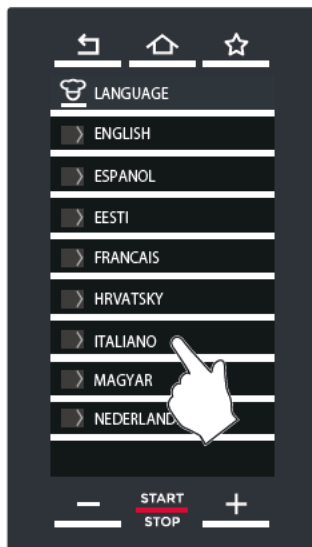

45

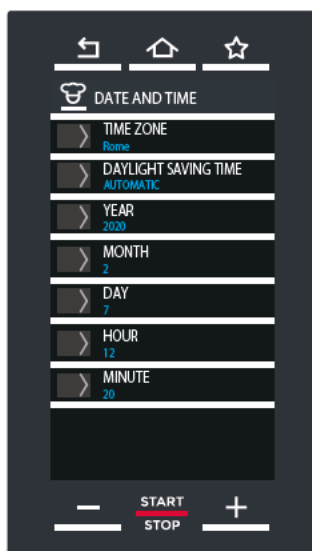

46

Unit of measurement

47 ▶ Select the unit of measurement for the:

- **temperature** (°C/°F);
- **volume** (litres or gallons);
- **thickness** (mm or inches);
- **weight** (kg or pounds);
- **energy** (kWh or BTU).

It also allows you to set the **current currency** (€, \$, etc.), and, by entering this menu, you can also set:

- whether the currency symbol should come before or after the value (symbol position);
- whether to use a decimal point “.” or comma “,” in decimal numbers (decimal sign).



47

Network

48 ▶ Lets you connect the oven to the Internet via a Wi-Fi or Ethernet connection.

Cloud PIN

The PIN code needed to connect the oven with DDC.unox.com and the app. Each oven has its own pre-set PIN code. The PIN code can be modified to connect to a personal DDC account; in this case, the oven must be paired.

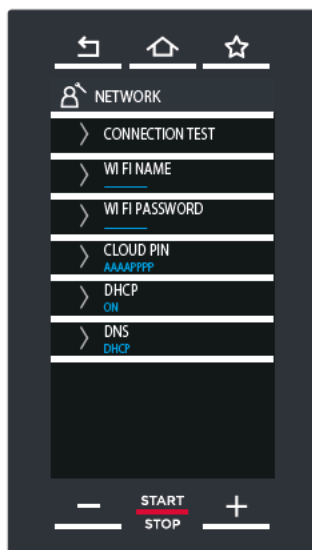

48

Consumables

49 ▶ It allows you to enter the cost of **electricity** and **water** (the currency is set in the “Unit of measurement” section).

USB

50 ▶ This section allows you to import or export materials from your own USB stick (FT32 formatted and with capacity between 4 and 16 GB).

The USB port is located below the LCD panel and allows you to import or export materials from your own USB stick (FT32 formatted and with capacity between 4 and 16 GB).

- EXPORT PROGRAMS ▶ exports recipes from the oven to a USB stick;
- IMPORT PROGRAMS ▶ imports recipes from the USB stick to the oven;
- IMPORT PICTURES ▶ imports pictures from the USB stick to the oven, e.g. an image of one of your particularly successful dishes.

To be used, the images must be converted: see ▶ 51

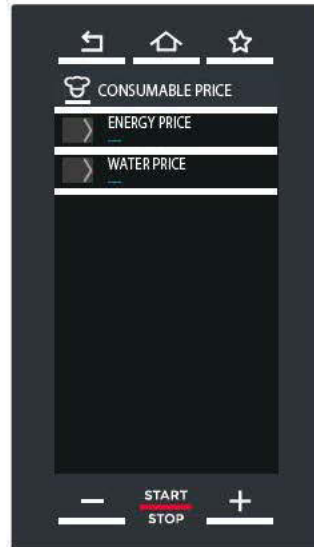

49



50

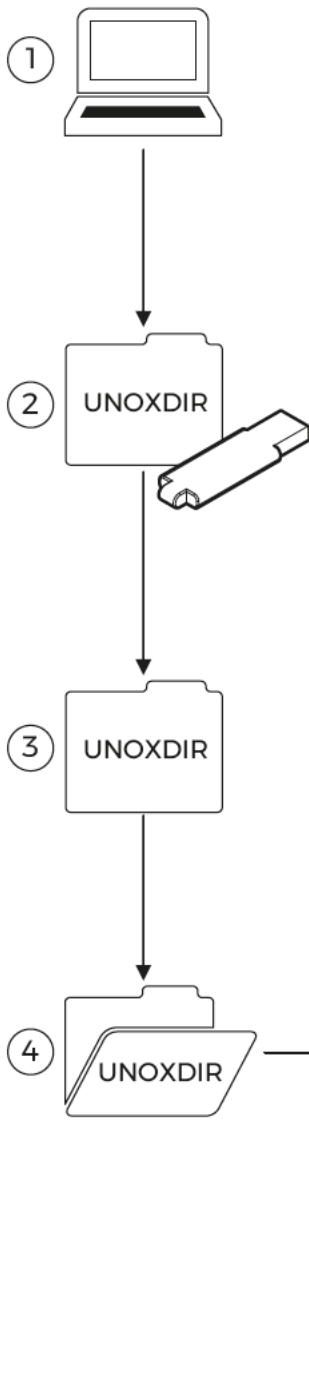

① Download the UNOXDIR.zip folder from the software section of UNOX Infonet

② Save the UNOXDIR.zip folder onto your USB stick

③ Unzip the UNOXDIR.zip folder that you have just downloaded

④ Open the UNOXDIR folder

⑤ There are two folders inside this folder (ZDATA and IMAGES) as well as an .exe file (IMAGECONVERTER.EXE)

⑥ Copy the images you want to use in the IMAGE folder

⑦ Start the IMAGECONVERTER.EXE program. You can now use the images!

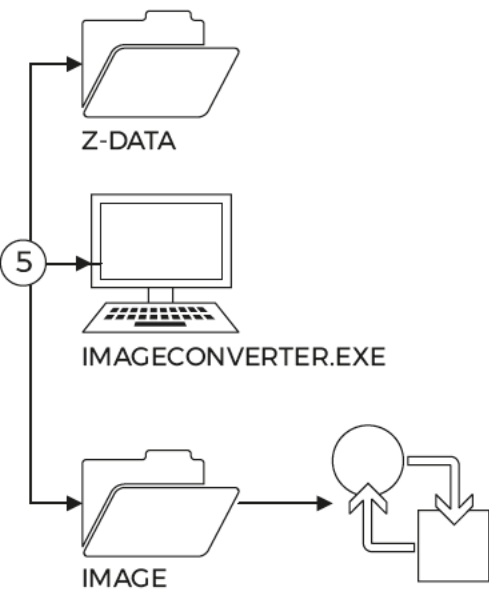

Options

This leads to four sub menus:

53 ► LOCKS

Lock PROGRAMS view)

This allows you to start the cooking programs stored by users but prevents them from being displayed, edited and deleted.

Lock user PROGRAMS)

This allows you to start and display the cooking programs stored by users but prevents them from being edited and deleted.

Lock manual cooking)

Blocks the possibility of manual cooking (SET menu).

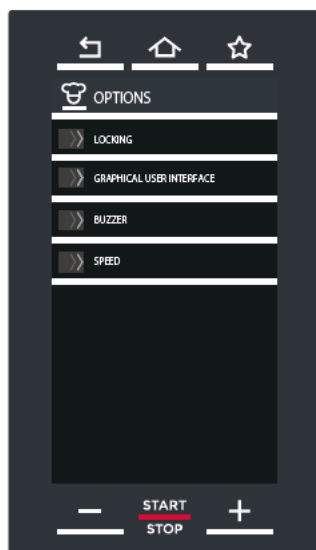

52

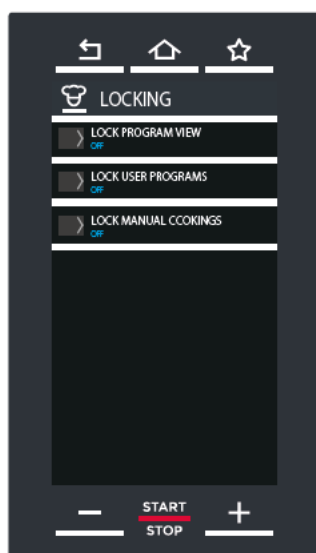

53

Consumption data in currency

When active (ON), it converts consumption data (e.g. litres used for steam) into costs, based on the currency set.

Seconds to show slides in cooking

Sets the number of seconds after which, with no interaction with the display, the screen with the cooking cycle in progress is displayed.

Lock screen timeout

If the oven door is opened, the screen to the side indicates that it is not possible to use the display for safety reasons. When the door is closed or after pressing and holding the “HOME” button, the screen can be used again. If the set value is:

- = “0” ► no screen appears even if the door is open;
- ≠ “0” ► the set value indicates the number of seconds after which the display unlocks once the door is closed. For example, if the value is set to “5”, the panel will unlock 5 seconds after the door has been closed.

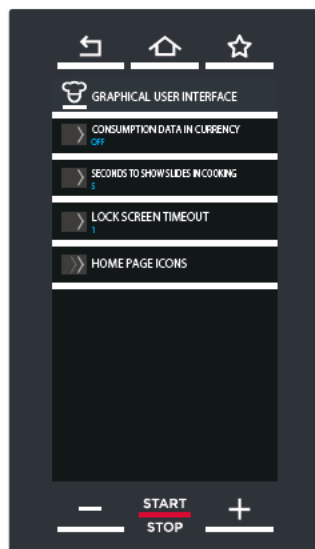

54

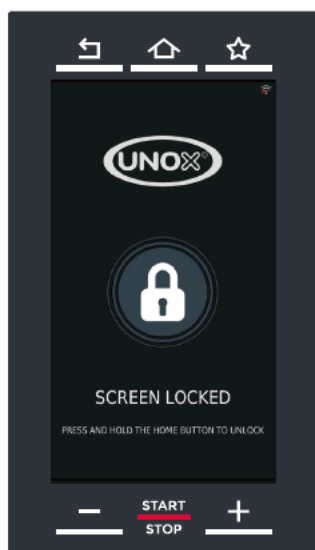

55

Home page icons

From this submenu, you can show, hide or deactivate the icons of the main menu (SET, PROGRAMS, etc.):

Settings:

- **SHOW** ▶ normal display of the selected icon
- **HIDE** ▶ hides the selected icon
- **SKIP** ▶ if some icons are skipped, the remaining icons rearrange themselves to fill the empty spaces
- **LOCK** ▶ lock the menu but leave it visible
- **DEACTIVATE** ▶ lock the menu and make it barely visible.

56 ▶ BUZZER

The following can be set:

- the **duration** of the buzzer at the end of the cooking cycle in seconds. Set the value using the keypad and confirm with "OK";
- the **volume** of the buzzer at the end of the cooking cycle, choosing from: high, medium or low;
- activation (ON) or deactivation (OFF) of an **optional external acoustic indicator**, if fitted.

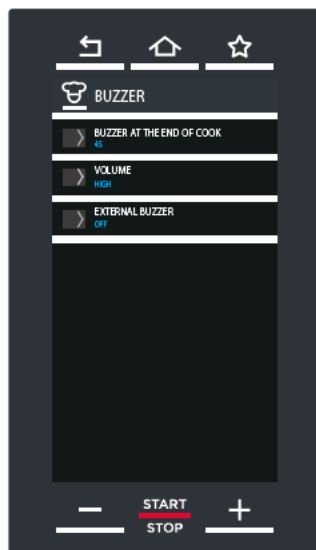

57 ► SPEED

This allows certain SPEED mode parameters to be set.

Default standby temperature

This shows which of the temperatures available in SPEED (shown on the STANDBY screen) will be automatically selected when switching to SPEED mode.

The possible alternatives are:

- **Ask every time:** each time you switch from BAKE to SPEED, you will be asked to select the required temperature for the SPEED mode which has just been started.
- **150°C / 180°C / 220°C / 260°C** (302°F / 356°F / 428°F / 500°F): each time you switch from BAKE to SPEED, the selected temperature is suggested (this can be modified by changing the temperature parameter in the cooking screen)
- **USER:** each time you switch from BAKE to SPEED the personal temperature (if set) will be suggested.

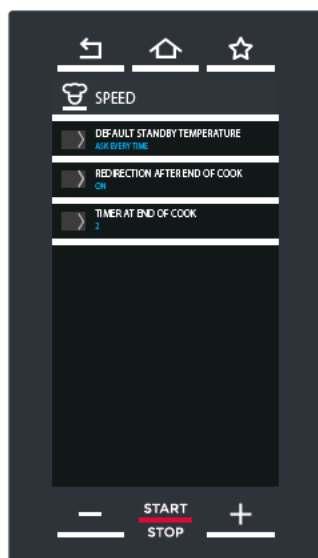

58

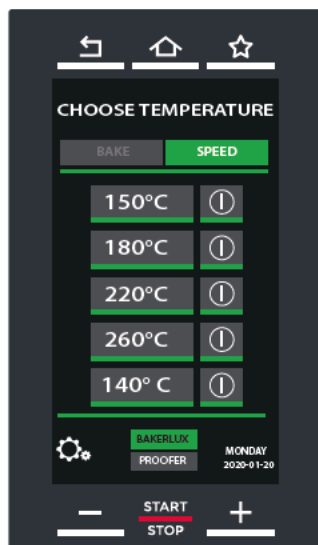

STANDBY screen: this screen only appears if “**Ask every time**” has been selected in the user settings menu

57

Redirection after end of cooking

If set to “ON”, after having removed the food from the cooking cavity at the end of a program, it allows you to automatically display the screen from which the program was previously started.

Timer at the end of cooking

(only if Redirection after end of cooking is set to “ON”) Time in seconds after which, once the food has been removed from the cavity at the end of a cooking cycle in a saved SPEED or SPEEDUNOX mode, the screen from which the program was started will be displayed.

UNOX SUPPORT

59 ▶ Here you will find the telephone numbers to be contacted for customer services.

SERVICE MENU

The “SERVICE MENU” section is for specialised technicians only and is therefore not accessible to users.

NETWORK

The “NETWORK” section can be accessed from this menu and from the “USER SETTINGS” menu.

▶ For more details, see p.69

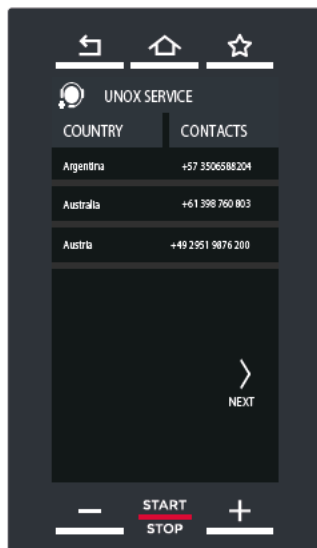

59

DDC STATS (DATA DRIVEN COOKING)

60 ▶ The screen provides access to 3 areas:

- **SET GOAL** ▶ you must set the daily number of oven operating hours, which is required to optimise costs. A histogram is then shown to indicate whether you achieved the goal. This helps you to understand whether you are using the oven in the best way possible.
- **HACCP DATA** ▶ Identifying HACCP data enables you to monitor the foods for which there is a risk of biological, chemical or physical contamination. More specifically, every 30 seconds the following readings are taken:
 - oven cavity temperature;
 - the temperature detected by the core probe or vacuum (neither of these are supported for this model);
- **CONSUMPTION** ▶ Tap the “consumption” icon to show the dates on which the oven was used.

SET GOAL



CONSUMPTION



HACCP DATA

Set goals

61

- 1 Select "SET GOAL".
- 2 Drag the blue bar or use the **- +** buttons to set the number of hours the oven should be used for per day, in order to optimise costs (e.g. 14 hours).
- 3 Press "SAVE".
- 4 Choose whether to display the goals for Days, Weeks or Months ▶ a histogram will appear showing:
 - the **blue bars** indicating when a goal has been reached i.e. the oven has been in operation for more than 14 hours.
 - the **red bars** indicating when a goal has NOT been reached i.e. the oven has NOT been in operation for more than 14 hours.

energy consumed
minutes door was open

View goals per week:
e.g. 18-24 December

17 hours: goal achieved

12 hours: goal NOT achieved

61

HACCP

- ① Select “HACCP”.
- ② Select **the day** for which you want to know the HACCP data.
- ③ The following data relating to the selected day is displayed.



62

F | Further information

HACCP protocol

HACCP is a set of prevention procedures, useful for ensuring the hygiene and healthiness of food. It starts with an analysis of the possible risks of bacterial, chemical or physical contamination at each stage of the production process and in subsequent stages such as storage, transportation and sale to the consumer.

They critical points are identified below; these are namely the steps in which contamination is more likely to occur.

Based on what is identified, constant control procedures are studied and applied at each stage of food processing, useful to prevent possible dangers.

Consumption

- ① Select "CONSUMPTION".
- ② Select the **day** for which you want to know the consumption data;
- ③ Select the **cooking cycle** for which you want to know the consumption data;
- ④ Energy consumption is displayed in kW/h.

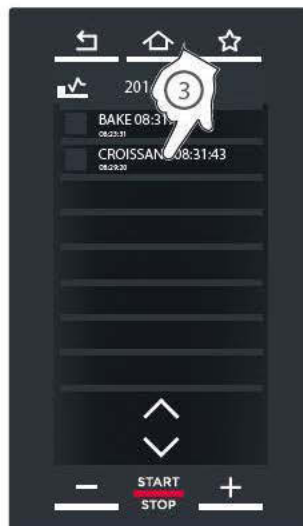

Maintenance

Safety information for maintaining the appliance	82
Cleaning	84
Inactivity	88
Disposal	90
Certification	90

SAFETY INFORMATION FOR MAINTAINING THE APPLIANCE



Any routine maintenance procedure must be performed:

- after disconnecting the appliance from the power supply and waiting for the capacitive components to discharge (approx. a few minutes;
- after waiting for the appliance to cool down fully;
- only if you are in good mental and physical condition, and are wearing suitable personal protective equipment (e.g. heat-resistant rubber gloves, eye protection, dust mask (optional), etc.).

Clean the appliance on a daily basis in order to maintain a good level of hygiene and to prevent the stainless steel from corroding or deteriorating.



Daily cleaning also reduces the possibility of accumulated fatty substances or food residues inside the cavity catching fire and becoming a fire hazard.

When cleaning any component or accessory NEVER use:

- abrasive, pointy or sharp tools or cloths (abrasive sponges, scrapers, steel-bristled brushes, etc.);
- steam or pressurised water jets;
- abrasive or powder detergents;
- alkaline, aggressive, caustic or corrosive detergents (e.g. hydrochloric/muriatic or sulphuric acid or caustic soda). These substances could cause permanent damage to the appliance surfaces and catalysts.

 Do not use these substances even when cleaning the appliance substructure or the floor under the appliance. The volatile emissions from these compounds may still cause damage.

 The appliance is equipped with a VOC catalyst which is located behind the inner wall of the oven cavity. It is used for cleaning the recirculation air flow.

If the catalyst is exposed to chemical detergents containing phosphates, NaOH, silicates, Na and potassium salts, irreversible damage may be caused. These chemicals are found in most commercial degreasers and detergents; therefore, we recommend using SPRAY&Rinse™ detergent, specifically designed for SPEED.Pro to maintain oven performance.

CLEANING

⚠ Wait for the appliance to cool down fully.

⚠ Clean the oven daily.

- 64 ▶ Open the oven door and remove the ▶ **plate and/or baking trays (A)**. Wash the plates/trays using a soft sponge and warm, soapy water. Rinse and dry thoroughly.

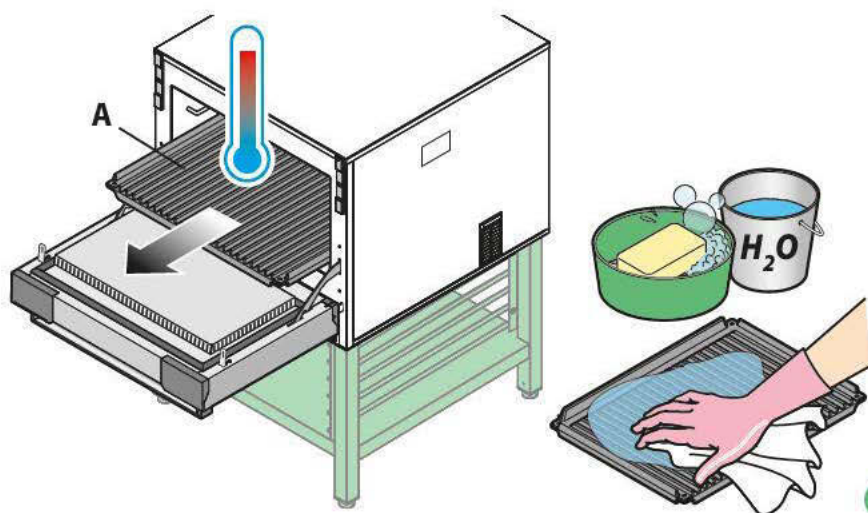

64

- 65 ▶ ① Clean the ▶ **seal (C)** using a soft cloth dampened in warm, soapy water. ② Start the "MANUAL CLEANING" function touching the icon in the oven home screen.
- 66 ▶ Depending on the current oven temperature, three different screens may appear:
 - Ⓐ the oven temperature is **lower** than expected: a heating phase starts ▶ wait for SPEED.Pro to reach the optimum temperature;
 - Ⓑ the oven temperature is **higher** than expected: a cooling phase starts, to be carried out with the door open ▶ wait for SPEED Pro to reach the optimum temperature;
 - Ⓒ the oven temperature is optimal for cleaning.

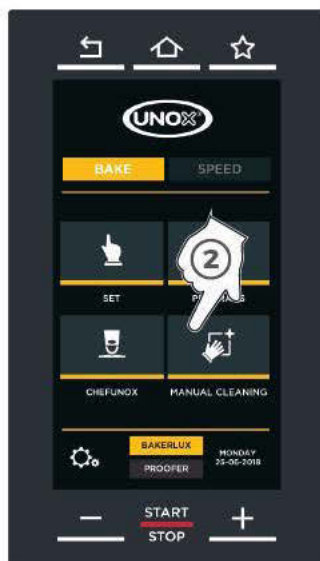
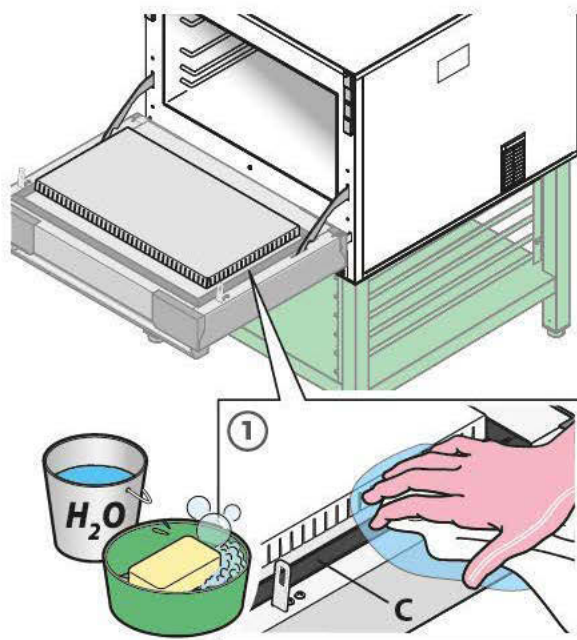

65

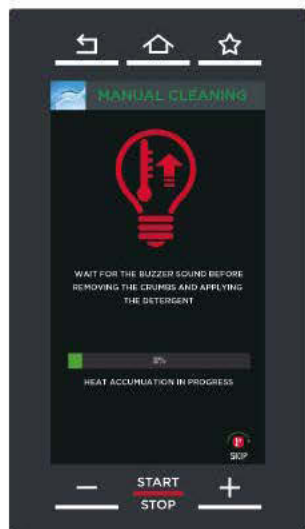

A temperature too low: wait for heating

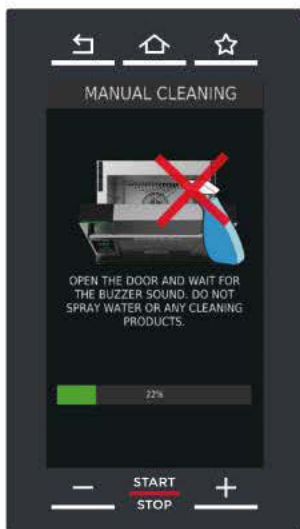

A temperature too high: wait for cooling

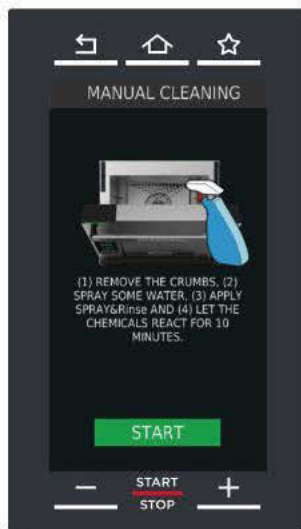

C correct temperature

66

- 67 ▶ When the oven has reached the optimal cleaning temperature, highlighted by the screen displayed (C) - figure 66, remove more substantial food residues from the **oven cavity** using kitchen roll or a clean, dry brush.
 - ⚠ Remove any crumbs from inside the cavity and especially from the ▶ **slits (B)** in the panel on the back of the door on a regular basis.

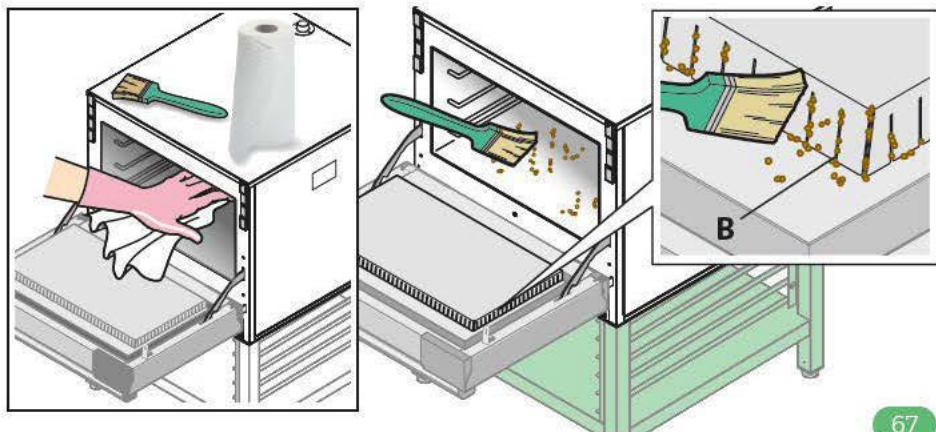

- 68 ▶ **Wearing rubber gloves and goggles**, spray UNOX SPRAY&RINSE inside the oven cavity without exaggerating. **DO NOT spray the product on the door seal "C"** as this may cause damage over time. By using this detergent, you are guaranteed excellent cleaning results. The product is fully compatible with the materials this appliance is made from. Alternatively, only use warm soapy water.
 - ⚠ **RISK OF FIRE:** do NOT clean using flammable detergents or detergents with potentially flammable substances. Only use UNOX SPRAY&Rinse or warm soapy water.
- 69 ▶ After spraying UNOX SPRAY&Rinse detergent (1) **LEAVE THE OVEN DOOR OPEN** and (2) wait about 10 minutes (you can see the time elapsed on the screen). A beep indicates that UNOX SPRAY&Rinse detergent has completed the cleaning process.

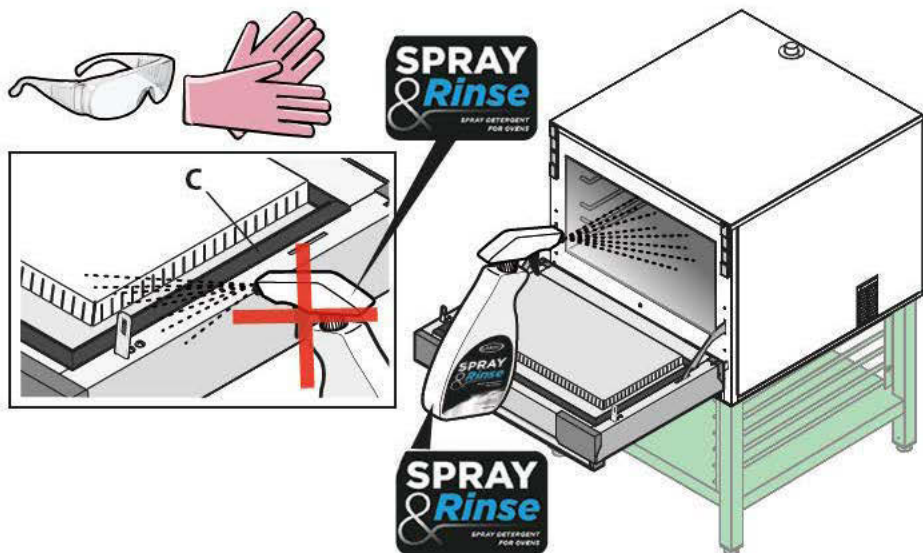

 **RISK OF FIRE:** do NOT clean using flammable detergents or detergents with potentially flammable substances. Only use UNOX SPRAY&Rinse or warm soapy water.

68

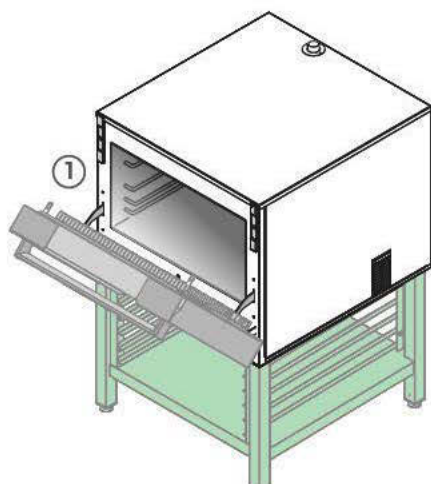

 **LEAVE THE DOOR OPEN throughout the entire process!**





If the door is closed during the cleaning process, a red screen will appear, indicating that the door should be reopened, accompanied by a continuous beep.

69

- **70** ▶ ① When the screen shown in the figure is displayed, it is possible ② to remove the softened residue with a soft sponge. Do not use abrasive, sharp or pointy tools or cloths (e.g. abrasive sponges, scrapers, steel brushes, etc.).
- Then, **thoroughly rinse** the oven cavity using a damp cloth to remove any trace of detergent. Dry with a clean cloth or kitchen roll.
-  **RISK OF FIRE:** Do NOT close the door until the oven cavity has been thoroughly rinsed. Detergent residues can produce flammable vapours if not removed.
- Close the oven door and clean the ▶ **external steel surfaces** with a soft cloth, dampened with soapy water. Take care to avoid seepage under the control panel. Rinse and dry carefully. Wipe steel surfaces regularly with a soft cloth doused in Vaseline oil to protect them.
- **71** ▶ Remove the ▶ **air filter (D)** from its magnetic housing and empty the crumb tray. Apply UNOX SPRAY&RINSE detergent over the entire surface of the filter and leave for 10 minutes. Rinse thoroughly and dry with a clean cloth. Put the filter back in place.

 Do not wash the suction filter in the dishwasher.

 The filter must be completely dry before starting the appliance.

 **SPEED.Pro™** does not work without the suction filter. There is a sensor to detect when it is there and warn you if it is not.

INACTIVITY

During periods of inactivity, take the following precautions:

- disconnect the appliance from the power supply;
- preferably rub a soft cloth lightly doused with Vaseline oil on all stainless steel surfaces;
- keep the appliance door slightly ajar.

Before reusing the appliance:

- clean the appliance and accessories thoroughly (see page **84**);
- reconnect the appliance to the power supply;
- inspect the appliance before using it again;
- restart the appliance for at least 50 minutes without any food inside and with the microwave set to 0%.

⊕ To ensure that the appliance is in perfect condition in terms of use and safety, maintenance and inspections should be performed at least yearly by an authorised support service centre.

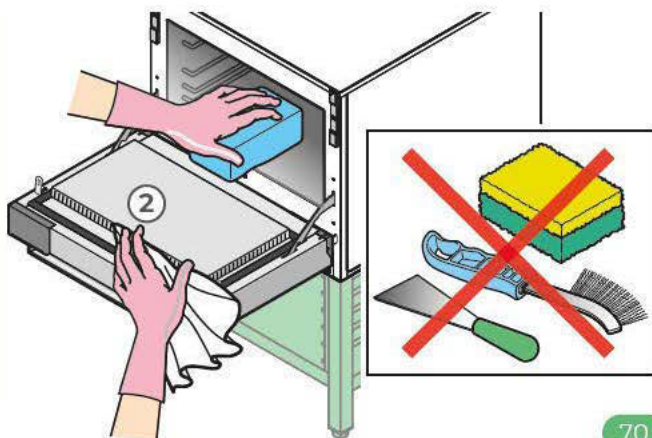

70

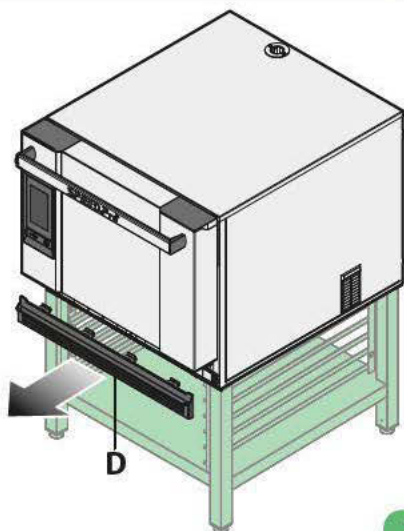
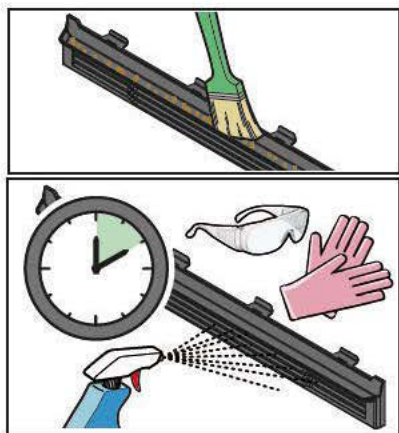

71

DISPOSAL (only European market)

Pursuant to article 13 of Italian Legislative Decree 49 of 2014
"Implementation of the WEEE Directive 2012/19/EU on waste electrical
and electronic equipment"



The crossed-out wheellie bin symbol indicates that the product was placed on the market after 13 August 2005 and that, at the end of its useful life, it should not be disposed of with other waste, but must be collected separately. All appliances are made with recyclable metals (stainless steel, iron, aluminium, galvanized steel, copper, etc.) in percentages above 90% by weight. Before disposal, ensure the appliance is unusable by removing the power cable and all compartment or cavity closure devices (where present). At the end of its useful life, the product must be disposed of in such a way as to reduce any negative impact on the environment and make efficient use of available resources. Prefer prevention, preparation for reuse, recycling and reclamation, and remember "the polluter pays". Please remember that illegal or incorrect disposal of the product incurs penalties, as provided for by current legislation.

Information on disposal in European Union countries.

The EU Directive on WEEE appliances has been implemented differently by each country. Therefore, if you want to dispose of this appliance, we recommend you contact your local authority or dealer for information on the correct disposal method.

CERTIFICATION (only European market)

EU declaration of conformity for electrical appliances

Manufacturer: UNOX S.p.A.

Address: Via Majorana, 22 - 35010 Cadoneghe, Padua, Italy

Declares, under its own responsibility, that the product

SPEED.Pro™

complies with the Machinery Directive 2006/42/EC through standards:

EN 60335-1:2012 + A11:2014 + A13:2017 + A1:2019 + A14:2019 + A2:2019 + A15:2021
EN 60335-2-42:2003 + A1:2008 + A11:2012
EN 60335-2-90:2006 + A1:2010
EN62233:2008

complies with the Electromagnetic Compatibility Directive 2014/30/EC through the following standards:

EN 55011:2016 + A1:2017 + A11:2020;
EN 61000-3-2:2014
EN 61000-3-3:2013
EN 61000-3-11:2000
EN 61000-3-12:2011
EN 61000-6-2:2005
EN 61000-6-3:2007 + A1:2011
ETSI EN 301 489-1: 2019, ETSI EN 301 489-17: 2020

Complies with Directive 2014/53/EU on Radio equipment through the following standards:
ETSI EN 300 328 V2.2.2 (2019)

CERTIFICATION (only U.S.A. and Canadian markets)



This oven complies with applicable sections of DHHS Federal Performance Standard 21 CFR 1030.10



With UL 923



with NSF ANSI 4 - CSA C22.2#150

Ventless operation: tested in accordance to EPA 202 Test Method, limits imposed by UL 710B

Support

After-sales
assistance

92

AFTER-SALES ASSISTANCE

In case of any malfunctions, disconnect the appliance from the power supply and consult the solutions proposed in the table ► **G** |

Troubleshooting on page **93**.

If the solution is not listed in the table, contact an authorised UNOX technical service centre, providing the following information:

- date of purchase;
- **72** ► the appliance data on the serial plate;
- any warning messages that appear on the display.

Manufacturer's information:

UNOX S.p.A.

Via Majorana, 22

35010 Cadoneghe (PD), Italy

Tel. (+39) 049 8657511 - Fax (+39) 049 8657555

info@unox.com www.unox.com

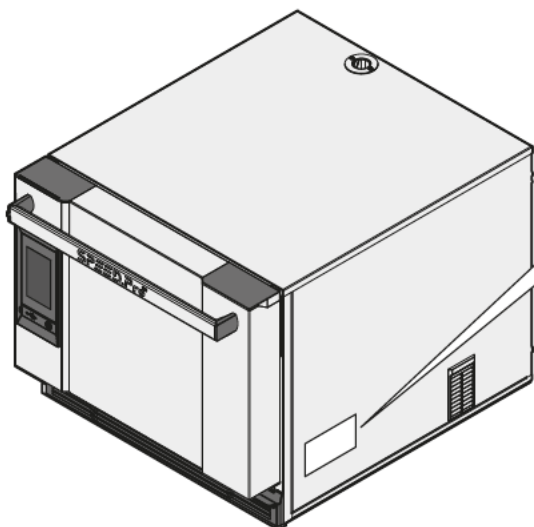

Serial number

Product code

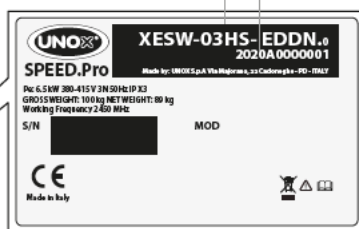

72

G | Troubleshooting

Fault	Possible cause	Possible solution	Solution
The oven is completely switched off.	<ul style="list-style-type: none"> No mains power. Appliance out of order. 	<ul style="list-style-type: none"> Make sure the appliance is connected to the electricity mains. 	Contact the Customer Assistance Service.
Cooking cycles not starting	<ul style="list-style-type: none"> Door open or not shut properly. 	<ul style="list-style-type: none"> Make sure the door is shut. 	



INVENTIVE SIMPLIFICATION

EUROPE

IT - ITALIA
UNOX S.p.a

E-mail: info@unox.it
Tel: +39 049 8657511

GB - UNITED KINGDOM
UNOX UK Ltd.

E-mail: info@unoxuk.com
Tel: +44 1252 851 522

CZ - ČESKÁ REPUBLIKA
UNOX DISTRIBUTION s.r.o.

E-mail: info.cz@unox.com
Tel: +420 241 940 000

BG - БЪЛГАРИЯ
UNOX BULGARIA

E-mail: info.bg@unox.com
Tel: +359 2 419 05 00

NL - NETHERLANDS
UNOX NETHERLANDS B.V.

E-mail: info.nl@unox.com
Tel: +31 6 27 21 14 10

DE - DEUTSCHLAND
UNOX DEUTSCHLAND GMBH

E-mail: info.de@unox.com
Tel: +49 2951 98760

IE - IRELAND
UNOX IRELAND

E-mail: info.ie@unox.com
Tel: +353 (0) 87 32 23 218

HR - HRVATSKA
UNOX CROATIA

E-mail: narudzbe@unox.com
Tel: +39 049 86 57 538

AT - ÖSTERREICH
UNOX ÖSTERREICH GMBH

E-mail: info.de@unox.com
Tel: +43 800 880 963

PL - POLSKA
Unox Polska Sp.z o.o.

E-mail: info.pl@unox.com
Tel: +48 665 232 000

FR - FRANCE, BELGIUM
& LUXEMBOURG
UNOX FRANCE s.a.s.

E-mail: info.fr@unox.com
Tel: +33 4 78 17 35 39

ES - ESPAÑA
UNOX PROFESIONAL
ESPAÑA S.L.

E-mail: info.es@unox.com
Tel: +34 900 82 89 43

TR - TÜRKİYE - UNOX TURKEY
Profesyonel mutfak ekipmanları
endüstri ve ticaret limited şirketi

E-mail: info.tr@unox.com
Tel: +90 530 176 62 03

RU - РОССИЯ, ПРИБАЛТИКА
И СТРАНЫ СНГ
UNOX РОССИЯ

E-mail: info.ru@unox.com
Tel: +7 (499) 702 - 00 - 14

SC - SCANDINAVIAN
COUNTRIES
UNOX SCANDINAVIA AB

E-mail: info.se@unox.com
Tel: +46(0)790 75 63 64

PT - PORTUGAL
UNOX PORTUGAL

E-mail: info.pt@unox.com
Tel: +351 918 228 787

AMERICA

US - U.S.A. & CANADA
UNOX Inc.

E-mail: info.usa@unox.com
Tel: +1 800 489 8669

AR - ARGENTINA
UNOX ARGENTINA

E-mail: info.ar@unox.com
Tel: +54 911 37 58 43 46

CO - COLOMBIA
UNOX COLOMBIA

E-mail: info.co@unox.com
Tel: +57 350 65 88 204

BR - UNOX BRASIL
SERVICOS LTDA.

E-mail: info.br@unox.com
Tel: +55 11 98717-8201

MX - MEXICO
UNOX MEXICO,
S. DE R.L. DE C.V.

E-mail: info.mx@unox.com
Tel: +52 55 8116-7720

ASIA, OCEANIA & AFRICA

ZA - SOUTH AFRICA
UNOX SOUTH AFRICA

E-mail: info.sa@unox.com
Tel: +27 845 05 52 35

PH - PHILIPPINES
UNOX PHILIPPINES

E-mail: info.asia@unox.com
Tel: +63 9175108084

AU - AUSTRALIA
UNOX AUSTRALIA PTY Ltd.

E-mail: info@unoxaustralia.com.au
Tel: +61 3 9876 0803

UZ - UZBEKISTAN
UNOX PRO LLC

E-mail: info.uz@unox.com
Tel: +998 90 370 90 10

KR - 대한민국
UNOX KOREA CO. Ltd.

E-mail: info.asia@unox.com
전화: +82 2 69410351

AC - OTHER
ASIAN COUNTRIES
UNOX (ASIA) SDN. BHD

E-mail: info.asia@unox.com
Tel: +603-58797700

TW - TAIWAN,
HONG KONG & MACAU
UNOX TAIWAN

E-mail: info.tw@unox.com
Tel: +886 928 250 536

MY - MALAYSIA
& SINGAPORE
UNOX (ASIA) SDN. BHD

E-mail: info.asia@unox.com
Tel: +603-58797700

CN - 中华人民共和国
UNOX TRADING (SHANGAI)
Ltd. CO.

电子邮件: info.asia@unox.com
电话: +603-58797700

NZ - NEW ZEALAND
UNOX NEW ZEALAND Ltd.

E-mail: info@unox.co.nz
Tel: +64 (0) 800 76 0803

AE - U.A.E.
UNOX MIDDLE EAST DMCC

E-mail: info.uae@unox.com
Tel: +971 4 554 2146

ID - INDONESIA
UNOX INDONESIA

E-mail: info.asia@unox.com
Tel: +62 81908852999

unox.com



L11887A4

All images used are for illustrative purposes only.
All features indicated in this catalogue may be subject to change and could be updated without notice.