

Parts Breakdown

Model CE-CN-G36TPF 43018

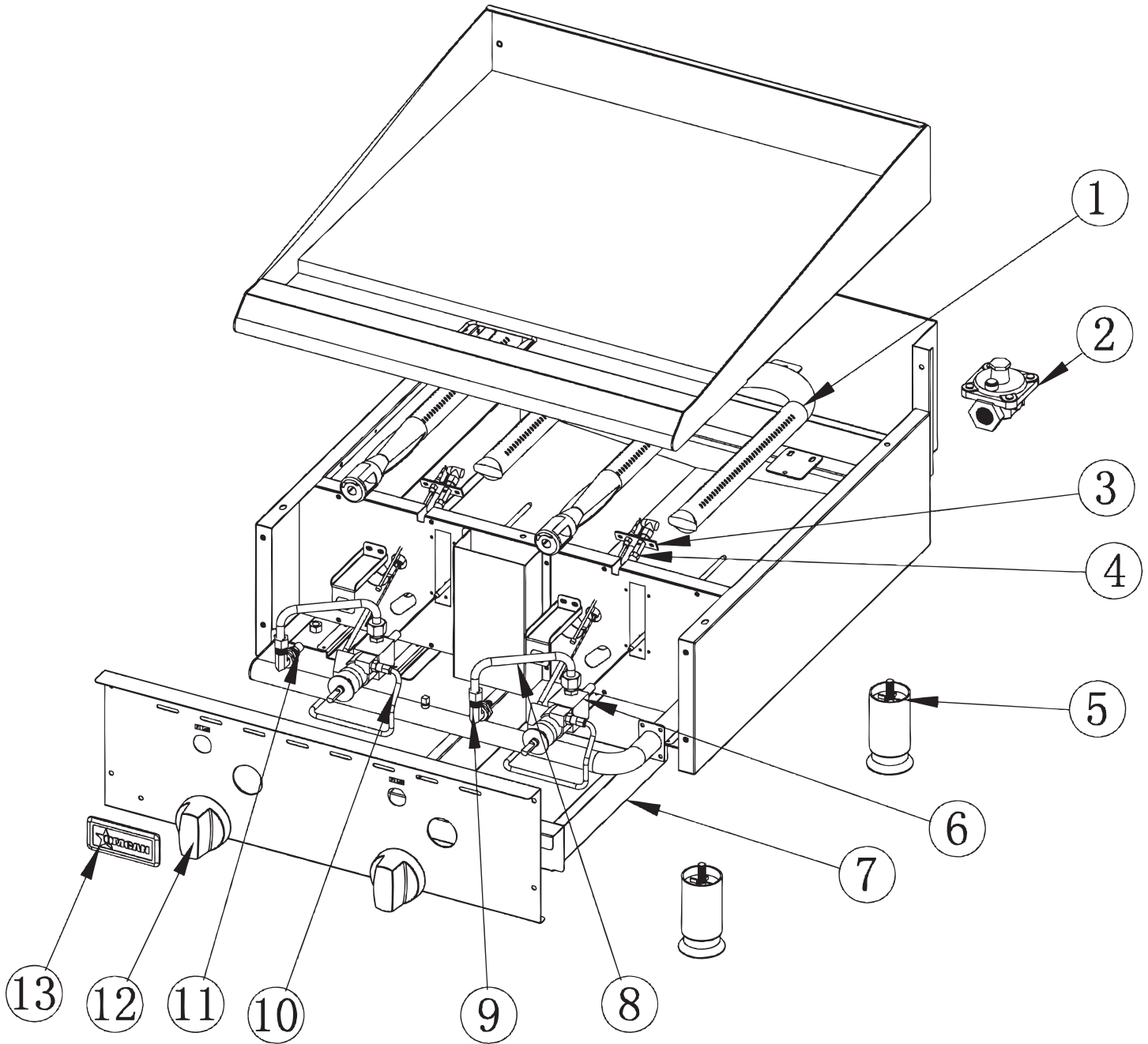



Parts Breakdown

Model CE-CN-G36TPF 43018

Item No.	Description	Position	Item No.	Description	Position	Item No.	Description	Position
73092	Burner for 43018	1	72411	Thermostat Valve for 43018	6	72416	Orifice 41 # NAT for 43018	11
72407	Regulator for 43018	2	72412	Tray for 43018	7	43315	Red Dial for Thermostat Control for 43018	12
72408	Flame Device System (Exclude Injector) for 43018	3	72413	Main Pipe Assy. for 43018	8	43313	Name Badge for Omcan for 43018	13
72409	ODS Injector-0.45 NAT for 43018	4	63534	Orifice Connection (Front) for 43018	9	43307	Conversion Kits for 43018	14
72410	Foot for 43018	5	72415	Pilot Pipe Assy. for 43018	10			